



345 GC

Hydraulic Excavator

Technical Specifications

Configurations and features may vary by region. Please consult your Cat® dealer for availability in your area.

Table of Contents

Specifications	2
Engine	2
Swing Mechanism	2
Weights	2
Track	2
Drive	2
Hydraulic System	2
Service Refill Capacities	2
Standards	2
Sound Performance	2
Operating Weights and Ground Pressures	3
Major Component Weights	3
Dimensions	4
Working Ranges and Forces	5
Reach Boom Lift Capacities – Counterweight: 9.0 mt (19,842 lb)	6
Mass Boom Lift Capacities – Counterweight: 9.0 mt (19,842 lb)	12
Bucket Specifications and Compatibility – Africa, Middle East and CIS	15
Bucket Specifications and Compatibility – Southeast Asia	16
Attachments Offering Guide – Africa, Middle East and CIS	17
Attachments Offering Guide – Southeast Asia	19
Standard and Optional Equipment	20
Dealer Installed Kit and Attachments	21

345 GC Hydraulic Excavator Specifications

Engine

Engine Model	Cat® C9.3B	
Net Power – ISO 9249	258 kW	346 hp
Engine Power – ISO 14396	259 kW	347 hp
Bore	115 mm	5 in
Stroke	149 mm	6 in
Displacement	9.3 L	568 in ³
Biodiesel capability	Up to B20 ⁽¹⁾	

- Meets China Nonroad Stage III emission standards, equivalent to U.S. EPA Tier 3 and EU Stage IIIA.
- Recommended for use up to 3300 m (10,830 ft) altitude with engine power derate above 2300 m (7,550 ft).
- Net power is tested per ISO 9249. Standards in effect at the time of manufacture.
- Net power advertised is the power available at the flywheel when the engine is equipped with fan, air intake system, exhaust system and alternator.
- Rated speed at 1,900 rpm.

⁽¹⁾Cat engines are compatible with the following renewable, alternative, and bio-fuels* with lower greenhouse gas emission impact:

- ✓ Up to B20 biodiesel (FAME)**
- ✓ Up to 100% HVO and GTL renewable fuels

*Refer to guidelines for successful application. Please consult your Cat dealer or “Caterpillar Machine Fluids Recommendations” (SEBU6250) for details.

**For use of blends up to B100, consult your Cat dealer.

Swing Mechanism

Swing Speed	8.27 rpm	
Maximum Swing Torque	155 kN·m	114,543 lbf-ft

Weights

Operating Weight	42 200 kg	93,000 lb
------------------	-----------	-----------

- Reach boom, R2.9TB (9'6") stick, HD 2.41 m³ (3.15 yd³) bucket, 600 mm (24") double grouser shoes, 9.0 mt (19,842 lb) counterweight.

Operating Weight	43 300 kg	95,500 lb
------------------	-----------	-----------

- Mass boom, M3.0UB (9'10") stick, SDV 2.77 m³ (3.62 yd³) bucket, 600 mm (24") double grouser shoes, 9.0 mt (19,842 lb) counterweight.

Track

Standard Track Shoes Width	600 mm	24 in
Optional Track Shoes Width	700 mm	28 in
Optional Track Shoes Width	800 mm	31 in
Number of Shoes (each side)	49	
Number of Track Rollers (each side)	8	
Number of Carrier Rollers (each side)	2	

Drive

Gradeability	35°/70%	
Maximum Travel Speed	5.2 km/h	3.2 mph
Maximum Drawbar Pull	292 kN	65,532 lbf

Hydraulic System

Main System – Maximum Flow – Implement	630 L/min (315 L/min × 2 pumps)	166 gal/min (83 gal/min × 2 pumps)
Maximum Pressure – Equipment – Implement	35 000 kPa	5,076 psi
Maximum Pressure – Travel	35 000 kPa	5,076 psi
Maximum Pressure – Swing	28 000 kPa	4,061 psi
Boom Cylinder – Bore	160 mm	6 in
Boom Cylinder – Stroke	1392 mm	55 in
Stick Cylinder – Bore	180 mm	7 in
Stick Cylinder – Stroke	1758 mm	69 in
TB Bucket Cylinder – Bore	150 mm	6 in
TB Bucket Cylinder – Stroke	1356 mm	53 in
UB Bucket Cylinder – Bore	160 mm	6 in
UB Bucket Cylinder – Stroke	1396 mm	55 in

Service Refill Capacities

Fuel Tank Capacity	600 L	158.5 gal
Cooling System	40 L	10.5 gal
Engine Oil (with filter)	32 L	8.5 gal
Swing Drive	13.5 L	3.6 gal
Final Drive (each)	8 L	2.1 gal
Hydraulic System (including tank)	423 L	111.7 gal
Hydraulic Tank (including suction pipe)	186 L	49.1 gal

Standards

Brakes	ISO 10265:2008
Cab/ROPS	ISO 12117-2:2008

Sound Performance

ISO 6395:2008 (external)	107 dB(A)
ISO 6396:2008 (inside cab)	73 dB(A)

- Hearing protection may be needed when operating with an open operator station and cab (when not properly maintained or doors/windows open) for extended periods or in a noisy environment.

345 GC Hydraulic Excavator Specifications

Operating Weights and Ground Pressures

	600 mm (24") Triple Grouser Shoes		600 mm (24") Double Grouser Shoes		600 mm (24") HD Triple Grouser Shoes		700 mm (28") Triple Grouser Shoes		800 mm (31") Triple Grouser Shoes	
	Ground Pressure		Ground Pressure		Ground Pressure		Ground Pressure		Ground Pressure	
	Weight kg (lb)	kPa (psi)	Weight kg (lb)	kPa (psi)	Weight kg (lb)	kPa (psi)	Weight kg (lb)	kPa (psi)	Weight kg (lb)	kPa (psi)
9.0 mt (19,842 lb) Counterweight + Base Machine										
Reach Boom + R3.35TB (11'0") Stick + 2.41 m ³ (3.15 yd ³) HD Bucket	41 500 (91,400)	77.3 (11.2)	42 200 (93,100)	78.7 (11.4)	42 100 (92,900)	78.5 (11.4)	41 800 (92,200)	66.8 (9.7)	42 500 (93,700)	59.3 (8.6)
Reach Boom + R2.9TB (9'6") Stick + 2.41 m ³ (3.15 yd ³) HD Bucket	41 400 (91,300)	77.2 (11.2)	42 200 (93,000)	78.6 (11.4)	42 100 (92,800)	78.4 (11.4)	41 800 (92,100)	66.7 (9.7)	42 400 (93,500)	59.3 (8.6)
Mass Boom + M3.0UB (9'10") Stick + 2.77 m ³ (3.62 yd ³) SDV Bucket	42 600 (93,800)	79.3 (11.5)	43 300 (95,500)	80.7 (11.7)	43 200 (95,300)	80.5 (11.7)	42 900 (94,600)	68.5 (9.9)	43 600 (96,100)	60.9 (8.8)
Mass Boom + M2.55UB (8'4") Stick + 2.77 m ³ (3.62 yd ³) SDV Bucket	42 400 (93,500)	79.0 (11.5)	43 200 (95,200)	80.4 (11.7)	43 100 (94 900)	80.2 (11.6)	42 800 (94,300)	68.3 (9.9)	43 400 (95,700)	60.6 (8.8)

All operating weights include a 90% fuel tank with 75 kg (165 lb) operator.

Major Component Weights

	kg	lb
Base machine with 9.0 mt (19,842 lb) counterweight, swing frame, two boom cylinders, and SD track rollers and carrier rollers	28 110	61,970
Track Shoes:		
600 mm (24") Width, 11 mm (0.43") Thick, Triple Grouser Track Shoes	4090	9,010
600 mm (24") Width, 15.5 mm (0.61") Thick, Double Grouser Track Shoes	4850	10,700
600 mm (24") Width, 15.5 mm (0.61") Thick, HD Triple Grouser Track Shoes	4750	10,460
700 mm (28") Width, 11 mm (0.43") Thick, Triple Grouser Track Shoes	4440	9,790
800 mm (31") Width, 13 mm (0.51") Thick, Triple Grouser Track Shoes	5100	11,230
Two Boom Cylinders	790	1,740
Weight of 90% Fuel Tank and 75 kg (165 lb) Operator	550	1,210
Counterweight:		
9.0 mt Counterweight	8990	19,842
Swing Frame:		
Swing Frame	3730	8,220
Undercarriage:		
Base Frame with SD Track Rollers and Carrier Rollers	8890	19,590
Booms (including lines, pins, stick cylinder):		
Reach Boom 6.9 m (22'8")	4020	8,870
Mass Boom 6.55 m (21'6")	4160	9,180
Sticks (including lines, pins, bucket cylinder, bucket linkage):		
Reach Stick R2.9TB (9'6")	2200	4,840
Reach Stick R3.35TB (11'0")	2250	4,960
Mass Stick M2.55UB (8'4")	2550	5,620
Mass Stick M3.0UB (9'10")	2710	5,980
Buckets (without linkage):		
2.41 m ³ (3.15 yd ³) HD	2460	5,410
2.77 m ³ (3.62 yd ³) SDV	2950	6,490

345 GC Hydraulic Excavator Specifications

Dimensions

All dimensions are approximate and may vary depending on bucket selection.

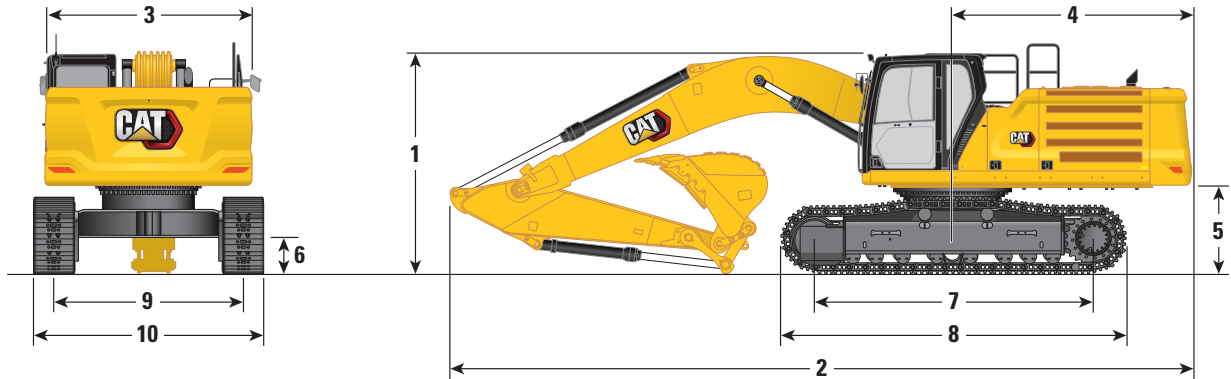

Boom Options	Reach Boom 6.9 m (22'8")				Mass Boom 6.55 m (21'6")			
	Reach Stick				Mass Stick			
	R3.35TB (11'0")		R2.9TB (9'6")		M3.0UB (9'10")		M2.55UB (8'4")	
Stick Options	mm	ft	mm	ft	mm	ft	mm	ft
1 Machine Height:								
Cab Height	3230	10.6	3230	10.6	3230	10.6	3230	10.6
FOGS Height (if equipped)	3370	11.1	3370	11.1	3370	11.1	3370	11.1
Handrails Height	3370	11.1	3370	11.1	3370	11.1	3370	11.1
With Boom/Stick/Bucket Installed	3560	11.7	3660	12.0	4040	13.3	3990	13.1
With Boom/Stick Installed	3490	11.5	3420	11.2	3880	12.7	3840	12.6
With Boom Installed	3050	10.0	3050	10.0	3080	10.1	3080	10.1
With Boom/Stick/Bucket Installed (with auxiliary lines)	3560	11.7	3660	12.0	4040	13.3	3990	13.1
With Boom/Stick Installed (with auxiliary lines)	3490	11.5	3420	11.2	3880	12.7	3840	12.6
With Boom Installed (with auxiliary lines)	3050	10.0	3050	10.0	3080	10.1	3080	10.1
2 Machine Length:								
With Boom/Stick/Bucket Installed	11 600	38.1	11 620	38.1	11 300	37.1	11 390	37.4
With Boom/Stick Installed	11 580	38.0	11 560	37.9	11 270	37.0	11 350	37.2
With Boom Installed	10 370	34.0	10 370	34.0	10 010	32.8	10 010	32.8
With Boom/Stick/Bucket Installed (with auxiliary lines)	11 600	38.1	11 620	38.1	11 300	37.1	11 390	37.4
With Boom/Stick Installed (with auxiliary lines)	11 580	38.0	11 560	37.9	11 270	37.0	11 350	37.2
With Boom Installed (with auxiliary lines)	10 370	34.0	10 370	34.0	10 010	32.8	10 010	32.8
3 Upperframe Width without Walkways	2970	9.7	2970	9.7	2970	9.7	2970	9.7
4 Tail Swing Radius	3530	11.6	3530	11.6	3530	11.6	3530	11.6
5 Counterweight Clearance	1300	4.3	1300	4.3	1300	4.3	1300	4.3
6 Ground Clearance	520	1.7	520	1.7	520	1.7	520	1.7
7 Length to Center of Rollers	4040	13.3	4040	13.3	4040	13.3	4040	13.3
8 Track Length	5030	16.5	5030	16.5	5030	16.5	5030	16.5
9 Track Gauge	2740	9.0	2740	9.0	2740	9.0	2740	9.0
10 Track Width/Undercarriage Width:								
600 mm (24") Shoes	3340	11.0	3340	11.0	3340	11.0	3340	11.0
700 mm (28") Shoes	3440	11.3	3440	11.3	3440	11.3	3440	11.3
800 mm (31") Shoes	3540	11.6	3540	11.6	3540	11.6	3540	11.6
Bucket Type	HD		HD		SDV		SDV	
Bucket Capacity	2.41 m ³	3.15 yd ³	2.41 m ³	3.15 yd ³	2.77 m ³	3.62 yd ³	2.77 m ³	3.62 yd ³
Bucket Tip Radius	1930 mm	6.3 ft	1930 mm	6.3 ft	2100 mm	6.9 ft	2100 mm	6.9 ft

345 GC Hydraulic Excavator Specifications

Working Ranges and Forces

All dimensions are approximate and may vary depending on bucket selection.

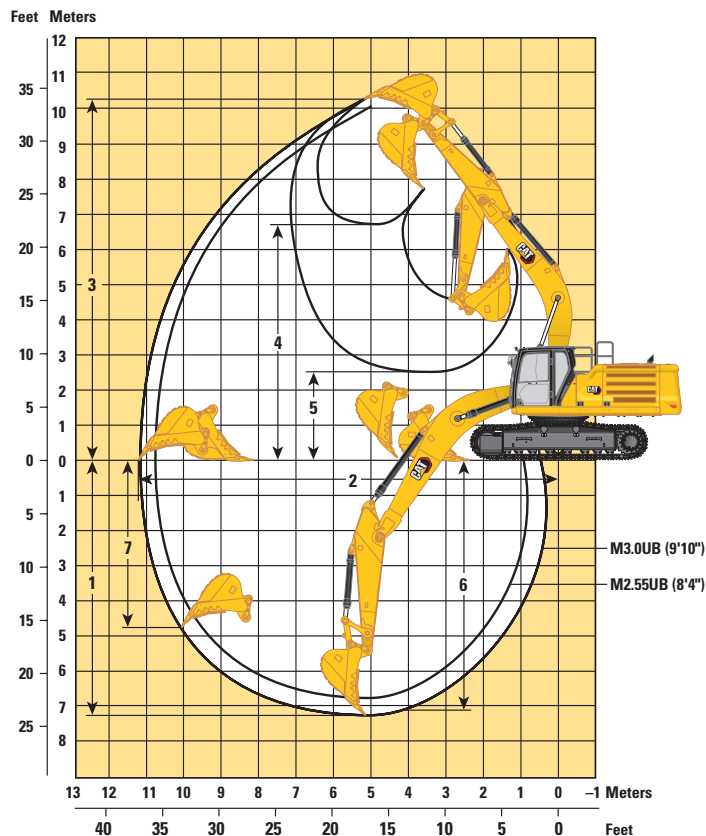
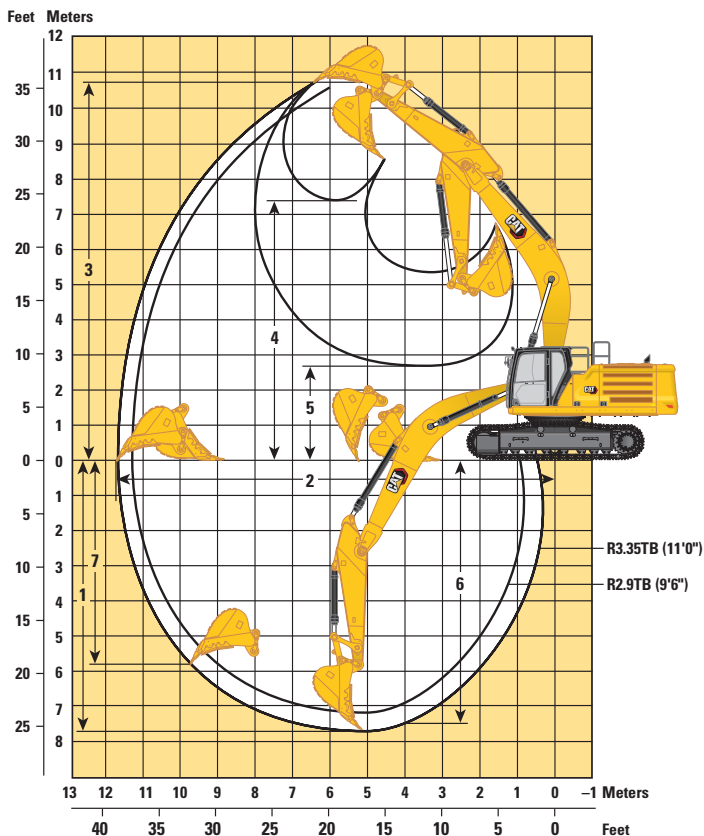

Boom Options

Reach Boom
6.9 m (22'8")

Mass Boom
6.55 m (21'6")

Stick Options

Reach Stick

Mass Stick

	R3.35TB (11'0")		R2.9TB (9'6")		M3.0UB (9'10")		M2.55UB (8'4")	
	mm	ft	mm	ft	mm	ft	mm	ft
1 Maximum Digging Depth	7650	25.1	7200	23.6	7280	23.9	6780	22.2
2 Maximum Reach at Ground Line	11 710	38.4	11 290	37.0	11 220	36.8	10 760	35.3
3 Maximum Cutting Height	10 720	35.2	10 540	34.6	10 250	33.6	10 060	33.0
4 Maximum Loading Height	7390	24.2	7210	23.7	6710	22.0	6510	21.4
5 Minimum Loading Height	2680	8.8	3130	10.3	2520	8.3	3020	9.9
6 Maximum Depth Cut for 2440 mm (8'0") Level Bottom	7500	25.0	7040	23.0	7130	23.0	6610	22.0
7 Maximum Vertical Wall Digging Depth	5800	19.0	5390	17.7	4760	15.6	4320	14.2
Bucket Digging Force (ISO)	235 kN	52,860 lbf	235 kN	52,860 lbf	262 kN	59,010 lbf	262 kN	59,010 lbf
Stick Digging Force (ISO)	180 kN	40,530 lbf	198 kN	44,550 lbf	190 kN	42,790 lbf	216 kN	48,540 lbf
Bucket Type	HD		HD		SDV		SDV	
Bucket Capacity	2.41 m ³	3.15 yd ³	2.41 m ³	3.15 yd ³	2.77 m ³	3.62 yd ³	2.77 m ³	3.62 yd ³
Bucket Tip Radius	1930 mm	6.3 ft	1930 mm	6.3 ft	2100 mm	6.9 ft	2100 mm	6.9 ft

345 GC Hydraulic Excavator Specifications

Reach Boom Lift Capacities – Counterweight: 9.0 mt (19,842 lb) – without Bucket

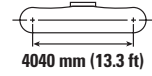
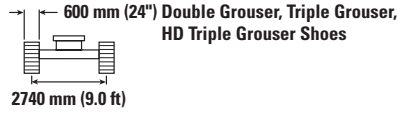
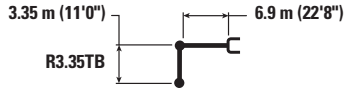

		3000 mm/120 in		4500 mm/180 in		6000 mm/240 in		7500 mm/300 in		9000 mm/360 in		mm in		
9000 mm 360 in	kg lb											*7200 *16,000	*7200 *16,000	7180 280
7500 mm 300 in	kg lb							*9150 *20,100	*9150 *20,100			*6750 *14,900	*6750 *14,900	8390 330
6000 mm 240 in	kg lb							*9500 *20,750	9400 20,200	*8000	6950	*6600 *14,550	*6600 *14,550	9190 360
4500 mm 180 in	kg lb			*15 650 *33,650	*15 650 *33,650	*12 100 *26,150	*12 100 *26,150	*10 200 *22,200	9050 19,500	*9100 *19,800	6800 14,600	*6700 *14,700	6000 13,250	9690 380
3000 mm 120 in	kg lb			*18 950 *40,750	18 050 38,950	*13 650 *29,500	11 950 25,750	*11 050 *23,900	8650 18,650	*9450 *20,550	6600 14,200	*6950 *15,300	5650 12,450	9950 400
1500 mm 60 in	kg lb			*16 950 *40,550	*16 950 *36,500	*14 800 *32,050	11 300 24,400	*11 650 *25,300	8300 17,900	9400 20,200	6400 13,800	*7450 *16,350	5500 12,150	9970 400
0 mm 0 in	kg lb			*18 350 *42,650	16 550 35,550	*15 200 *32,900	10 950 23,550	*11 950 *25,850	8050 17,350	9250 19,900	6250 13,450	*8250 *18,100	5600 12,300	9750 390
-1500 mm -60 in	kg lb	*12 550 *28,400	*12 550 *28,400	*19 300 *41,850	16 500 35,400	*14 750 *32,000	10 750 23,200	*11 650 *25,150	7900 17,050	9200 19,750	6200 13,350	*8800 *19,350	5950 13,100	9300 370
-3000 mm -120 in	kg lb	*20 150 *45,550	*20 150 *45,550	*17 200 *37,300	16 650 35,750	*13 500 *29,150	10 800 23,250	*10 600 *22,750	7950 17,100			*8650 *19,050	6700 14,850	8550 340
-4500 mm -180 in	kg lb	*17 350 *37,400	*17 350 *37,400	*14 050 *30,150	*14 050 *30,150	*11 050 *23,600	11 000 *23,600					*8200 *17,950	*8200 *17,950	7430 290



ISO 10567



* Indicates that the load is limited by hydraulic lifting capacity rather than tipping load. The above loads are in compliance with hydraulic excavator lift capacity standard ISO 10567:2007. They do not exceed 87% of hydraulic lifting capacity or 75% of tipping load. Weight of all lifting accessories must be deducted from the above lifting capacities. Lifting capacities are based on the machine standing on a firm, uniform supporting surface. The use of a work tool attachment point to handle/lift objects, could affect the machine lift performance.

Lift capacity stays with ±5% for all available track shoes.

Always refer to the appropriate Operation and Maintenance Manual for specific product information.

345 GC Hydraulic Excavator Specifications

Reach Boom Lift Capacities – Counterweight: 9.0 mt (19,842 lb) – without Bucket

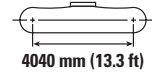
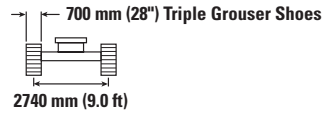
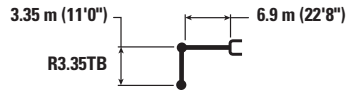

		3000 mm/120 in		4500 mm/180 in		6000 mm/240 in		7500 mm/300 in		9000 mm/360 in		mm in		
9000 mm 360 in	kg lb											*7200 *16,000	*7200 *16,000	7180 280
7500 mm 300 in	kg lb							*9150 *20,100	*9150 *20,100			*6750 *14,900	*6750 *14,900	8390 330
6000 mm 240 in	kg lb							*9500 *20,750	9300 20,000	*8000	6900	*6600 *14,550	*6600 *14,550	9190 360
4500 mm 180 in	kg lb			*15 650 *33,650	*15 650 *33,650	*12 100 *26,150	*12 100 *26,150	*10 200 *22,200	9000 19,350	*9100 *19,800	6750 14,450	*6700 *14,700	5950 13,150	9690 380
3000 mm 120 in	kg lb			*18 950 *40,750	17 900 38,650	*13 650 *29,500	11 850 25,550	*11 050 *23,900	8600 18,500	*9450 20,450	6550 14,050	*6950 *15,300	5600 12,300	9950 400
1500 mm 60 in	kg lb			*16 950 *40,550	16 800 36,200	*14 800 *32,050	11 200 24,200	*11 650 *25,300	8250 17,700	9300 20,000	6350 13,650	*7450 *16,350	5450 12,000	9970 400
0 mm 0 in	kg lb			*18 350 *42,650	16 400 35,250	*15 200 *32,900	10 850 23,350	11 900 25,600	7950 17,150	9150 19,700	6200 13,350	8150 17,950	5550 12,200	9750 390
-1500 mm -60 in	kg lb	*12 550 *28,400	*12 550 *28,400	*19 300 *41,850	16 350 35,100	*14 750 *32,000	10 650 23,000	*11 650 *25,150	7850 16,900	9100 19,600	6150 13,250	8700 19,200	5900 13,000	9300 370
-3000 mm -120 in	kg lb	*20 150 *45,550	*20 150 *45,550	*17 200 *37,300	16 500 35,400	*13 500 *29,150	10 700 23,050	*10 600 *22,750	7850 16,950			*8650 *19,050	6650 14,700	8550 340
-4500 mm -180 in	kg lb	*17 350 *37,400	*17 350 *37,400	*14 050 *30,150	*14 050 *30,150	*11 050 *23,600	10 900 23,550					*8200 *17,950	*8200 *17,950	7430 290



ISO 10567



* Indicates that the load is limited by hydraulic lifting capacity rather than tipping load. The above loads are in compliance with hydraulic excavator lift capacity standard ISO 10567:2007. They do not exceed 87% of hydraulic lifting capacity or 75% of tipping load. Weight of all lifting accessories must be deducted from the above lifting capacities. Lifting capacities are based on the machine standing on a firm, uniform supporting surface. The use of a work tool attachment point to handle/lift objects, could affect the machine lift performance.

Lift capacity stays with ±5% for all available track shoes.

Always refer to the appropriate Operation and Maintenance Manual for specific product information.

345 GC Hydraulic Excavator Specifications

Reach Boom Lift Capacities – Counterweight: 9.0 mt (19,842 lb) – without Bucket

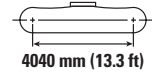
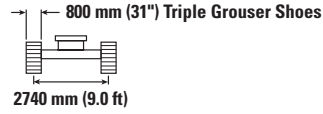
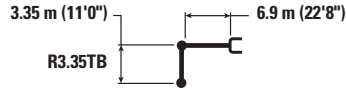

		3000 mm/120 in		4500 mm/180 in		6000 mm/240 in		7500 mm/300 in		9000 mm/360 in		mm in		
9000 mm 360 in	kg lb											*7200 *16,000	*7200 *16,000	7180 280
7500 mm 300 in	kg lb							*9150 *20,100	*9150 *20,100			*6750 *14,900	*6750 *14,900	8390 330
6000 mm 240 in	kg lb							*9500 *20,750	9450 20,300	*8000	6950	*6600 *14,550	*6600 *14,550	9190 360
4500 mm 180 in	kg lb			*15 650 *33,650	*15 650 *33,650	*12 100 *26,150	*12 100 *26,150	*10 200 *22,200	9100 19,600	*9100 *19,800	6850 14,700	*6700 *14,700	6050 13,350	9690 380
3000 mm 120 in	kg lb			*18 950 *40,750	18 150 39,150	*13 650 *29,500	12 000 25,900	*11 050 *23,900	8700 18,750	*9450 *20,550	6650 14,250	*6950 *15,300	5700 12,500	9950 400
1500 mm 60 in	kg lb			*16 950 *40,550	*16 950 *36,700	*14 800 *32,050	11 400 24,550	*11 650 *25,300	8350 18,000	9450 20,350	6450 13,850	*7450 *16,350	5550 12,200	9970 400
0 mm 0 in	kg lb			*18 350 *42,650	16 650 35,750	*15 200 *32,900	11 000 23,700	*11 950 *25,850	8100 17,450	9300 20,000	6300 13,550	*8250 *18,100	5650 12,400	9750 390
-1500 mm -60 in	kg lb	*12 550 *28,400	*12 550 *28,400	*19 300 *41,850	16 550 35,600	*14 750 *32,000	10 850 23,300	*11 650 *25,150	7950 17,150	9250 *19,850	6250 13,450	*8800 *19,350	6000 13,200	9300 370
-3000 mm -120 in	kg lb	*20 150 *45,550	*20 150 *45,550	*17 200 *37,300	16 700 35,900	*13 500 *29,150	10 850 23,400	*10 600 *22,750	8000 17,200			*8650 *19,050	6750 14,900	8550 340
-4500 mm -180 in	kg lb	*17 350 *37,400	*17 350 *37,400	*14 050 *30,150	*14 050 *30,150	*11 050 *23,600	*11 050 *23,600					*8200 *17,950	*8200 *17,950	7430 290



ISO 10567



* Indicates that the load is limited by hydraulic lifting capacity rather than tipping load. The above loads are in compliance with hydraulic excavator lift capacity standard ISO 10567:2007. They do not exceed 87% of hydraulic lifting capacity or 75% of tipping load. Weight of all lifting accessories must be deducted from the above lifting capacities. Lifting capacities are based on the machine standing on a firm, uniform supporting surface. The use of a work tool attachment point to handle/lift objects, could affect the machine lift performance.

Lift capacity stays with ±5% for all available track shoes.

Always refer to the appropriate Operation and Maintenance Manual for specific product information.

345 GC Hydraulic Excavator Specifications

Reach Boom Lift Capacities – Counterweight: 9.0 mt (19,842 lb) – without Bucket

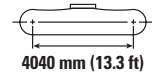
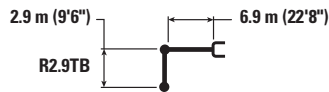

		3000 mm/120 in		4500 mm/180 in		6000 mm/240 in		7500 mm/300 in		9000 mm/360 in		mm in		
9000 mm 360 in	kg lb											*8600 *19,150	*8600 *19,150	6600 260
7500 mm 300 in	kg lb							*9750 *20,850	9400 20,150			*8000 *17,700	*8000 *17,700	7890 310
6000 mm 240 in	kg lb					*11 300 *24,450	*11 300 *24,450	*9950 *21,750	9250 19,900			*7850 *17,250	7200 15,950	8740 350
4500 mm 180 in	kg lb			*16 800 *35,950	*16 800 *35,950	*12 700 *27,400	12 500 26,950	*10 600 *23,000	8950 19,250	*9400 *20,050	6750 14,450	*7950 *17,450	6400 14,150	9270 370
3000 mm 120 in	kg lb			*18 950 *42,700	17 600 38,000	*14 150 *30,500	11 800 25,400	*11 350 *24,550	8600 18,500	9550 20,550	6550 14,100	*8300 *18,200	6000 13,200	9530 380
1500 mm 60 in	kg lb			*12 600 *30,850	*12 600 *30,850	*15 050 *32,600	11 200 24,200	*11 850 *25,650	8250 17,800	9350 20,150	6400 13,750	8600 18,900	5850 12,900	9550 380
0 mm 0 in	kg lb			*17 000 *39,700	16 550 35,550	*15 200 *32,900	10 900 23,500	*11 950 *25,850	8050 17,300	9250 19,900	6250 13,500	8800 19,350	6000 13,150	9330 370
-1500 mm -60 in	kg lb	*12 550 *28,600	*12 550 *28,600	*18 550 *40,300	16 550 35,600	*14 500 *31,450	10 800 23,250	*11 450 *24,750	7950 17,150			*9150 *20,150	6400 14,100	8850 350
-3000 mm -120 in	kg lb	*19 350 *42,300	*19 350 *42,300	*16 250 *35,200	*16 250 *35,200	*12 950 *27,950	10 900 23,450	*10 100 *21,500	8000 17,300			*8900 *19,600	7350 16,200	8060 320
-4500 mm -180 in	kg lb			*12 650 *27,150	*12 650 *27,150	*10 050 *21,250	*10 050 *21,250					*8200 *17,900	*8200 *17,900	6860 270



ISO 10567



* Indicates that the load is limited by hydraulic lifting capacity rather than tipping load. The above loads are in compliance with hydraulic excavator lift capacity standard ISO 10567:2007. They do not exceed 87% of hydraulic lifting capacity or 75% of tipping load. Weight of all lifting accessories must be deducted from the above lifting capacities. Lifting capacities are based on the machine standing on a firm, uniform supporting surface. The use of a work tool attachment point to handle/lift objects, could affect the machine lift performance.

Lift capacity stays with ±5% for all available track shoes.

Always refer to the appropriate Operation and Maintenance Manual for specific product information.

345 GC Hydraulic Excavator Specifications

Reach Boom Lift Capacities – Counterweight: 9.0 mt (19,842 lb) – without Bucket

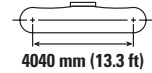
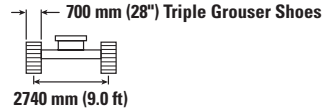
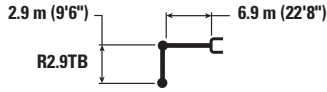

	3000 mm/120 in		4500 mm/180 in		6000 mm/240 in		7500 mm/300 in		9000 mm/360 in				mm in	
	kg lb	kg lb	kg lb	kg lb	kg lb	kg lb	kg lb	kg lb	kg lb	kg lb	kg lb	kg lb		
9000 mm 360 in												*8600 *19,150	*8600 *19,150	6600 260
7500 mm 300 in							*9750 *20,850	9350 20,000				*8000 *17,700	*8000 *17,700	7890 310
6000 mm 240 in					*11 300 *24,450	*11 300 *24,450	*9950 *21,750	9200 19,750				*7850 *17,250	7150 15,850	8740 350
4500 mm 180 in			*16 800 *35,950	*16 800 *35,950	*12 700 *27,400	12 400 26,750	*10 600 *23,000	8900 19,100	*9400 *20,050	6650 14,300		*7950 *17,450	6350 14,050	9270 370
3000 mm 120 in			*18 950 *42,700	17 450 37,700	*14 150 *30,500	11 700 25,200	*11 350 *24,550	8500 18,350	9450 20,350	6500 13,950		*8300 *18,200	5950 13,100	9530 380
1500 mm 60 in			*12 600 *30,850	*12 600 *30,850	*15 050 *32,600	11 100 23,950	*11 850 *25,650	8200 17,650	9300 20,000	6350 13,600		8500 18,750	5800 12,750	9550 380
0 mm 0 in			*17 000 *39,700	16 400 35,250	*15 200 *32,900	10 800 23,250	11 900 25,600	7950 17,150	9150 19,700	6200 13,400		8700 19,200	5900 13,000	9330 370
-1500 mm -60 in		*12 550 *28,600	*12 550 *28,600	*18 550 *40,300	16 450 35,300	*14 500 *31,450	10 700 23,050	*11 450 *24,750	7900 16,950			*9150 *20,150	6350 14,000	8850 350
-3000 mm -120 in		*19 350 *42,300	*19 350 *42,300	*16 250 *35,200	*16 250 *35,200	*12 950 *27,950	10 800 23,250	*10 100 *21,500	7950 17,150			*8900 *19,600	7250 16,050	8060 320
-4500 mm -180 in				*12 650 *27,150	*12 650 *27,150	*10 050 *21,250	*10 050 *21,250					*8200 *17,900	*8200 *17,900	6860 270



ISO 10567



* Indicates that the load is limited by hydraulic lifting capacity rather than tipping load. The above loads are in compliance with hydraulic excavator lift capacity standard ISO 10567:2007. They do not exceed 87% of hydraulic lifting capacity or 75% of tipping load. Weight of all lifting accessories must be deducted from the above lifting capacities. Lifting capacities are based on the machine standing on a firm, uniform supporting surface. The use of a work tool attachment point to handle/lift objects, could affect the machine lift performance.

Lift capacity stays with ±5% for all available track shoes.

Always refer to the appropriate Operation and Maintenance Manual for specific product information.

345 GC Hydraulic Excavator Specifications

Reach Boom Lift Capacities – Counterweight: 9.0 mt (19,842 lb) – without Bucket

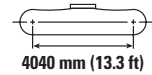
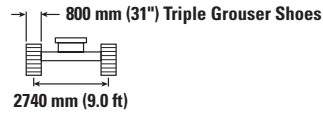
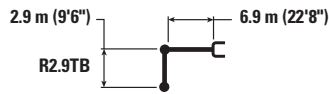

	3000 mm/120 in		4500 mm/180 in		6000 mm/240 in		7500 mm/300 in		9000 mm/360 in					
	kg	lb	kg	lb	kg	lb	kg	lb	kg	lb	kg	lb	mm	in
9000 mm 360 in												*8600 *19,150	*8600 *19,150	6600 260
7500 mm 300 in							*9750 *20,850	9450 20,250				*8000 *17,700	*8000 *17,700	7890 310
6000 mm 240 in					*11 300 *24,450	*11 300 *24,450	*9950 *21,750	9300 20,000				*7850 *17,250	7250 16,050	8740 350
4500 mm 180 in			*16 800 *35,950	*16 800 *35,950	*12 700 *27,400	12 550 27,100	*10 600 *23,000	9000 19,350	*9400 *20,050	6750 14,500		*7950 *17,450	6450 14,250	9270 370
3000 mm 120 in			*18 950 *42,700	17 700 38,200	*14 150 *30,500	11 850 25,550	*11 350 *24,550	8650 18,600	9600 20,650	6600 14,150		*8300 *18,200	6050 13,300	9530 380
1500 mm 60 in			*12 600 *30,850	*12 600 *30,850	*15 050 *32,600	11 300 24,300	*11 850 *25,650	8300 17,900	9450 20,300	6400 13,800		8650 19,000	5900 12,950	9550 380
0 mm 0 in			*17 000 *39,700	16 650 35,750	*15 200 *32,900	10 950 23,600	*11 950 *25,900	8100 17,400	9300 20,050	6300 13,600		8850 19,500	6000 13,250	9330 370
-1500 mm -60 in		*12 550 *28,600	*12 550 *28,600	*18 550 *40,300	16 650 35,800	*14 500 *31,450	10 850 23,400	*11 450 *24,750	8000 17,250			*9150 *20,150	6450 14,200	8850 350
-3000 mm -120 in		*19 350 *42,300	*19 350 *42,300	*16 250 *35,200	*16 250 *35,200	*12 950 *27,950	10 950 23,550	*10 100 *21,500	8050 17,400			*8900 *19,600	7350 16,300	8060 320
-4500 mm -180 in				*12 650 *27,150	*12 650 *27,150	*10 050 *21,250	*10 050 *21,250					*8200 *17,900	*8200 *17,900	6860 270



ISO 10567



* Indicates that the load is limited by hydraulic lifting capacity rather than tipping load. The above loads are in compliance with hydraulic excavator lift capacity standard ISO 10567:2007. They do not exceed 87% of hydraulic lifting capacity or 75% of tipping load. Weight of all lifting accessories must be deducted from the above lifting capacities. Lifting capacities are based on the machine standing on a firm, uniform supporting surface. The use of a work tool attachment point to handle/lift objects, could affect the machine lift performance.

Lift capacity stays with ±5% for all available track shoes.

Always refer to the appropriate Operation and Maintenance Manual for specific product information.

345 GC Hydraulic Excavator Specifications

Mass Boom Lift Capacities – Counterweight: 9.0 mt (19,842 lb) – without Bucket

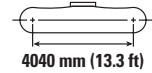
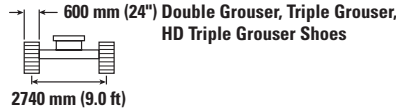
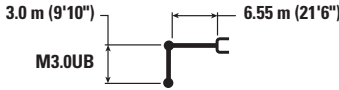

		3000 mm/120 in		4500 mm/180 in		6000 mm/240 in		7500 mm/300 in		9000 mm/360 in		mm in		
7500 mm 300 in	kg lb							*8400	*8400			*7900 *17,500	*7900 *17,500	7570 300
6000 mm 240 in	kg lb							*9500 *20,750	9000 19,250			*7650 *16,900	7300 16,200	8450 330
4500 mm 180 in	kg lb			*15 250 *32,750	*15 250 *32,750	*11 850 *25,600	*11 850 *25,600	*10 050 *21,850	8650 18,600			*7750 *17,000	6400 14,100	9000 360
3000 mm 120 in	kg lb			*18 400 *39,500	17 550 37,850	*13 300 *28,700	11 500 24,800	*10 750 *23,300	8250 17,800	9200 19,800	6200 13,300	*8050 *17,700	5900 13,050	9270 370
1500 mm 60 in	kg lb			*20 000 *43,250	16 400 35,300	*14 350 *31,050	10 850 23,400	*11 300 *24,500	7900 17,000	9050 19,400	6050 12,950	8600 18,950	5750 12,650	9290 370
0 mm 0 in	kg lb			*19 850 *43,050	15 950 34,350	*14 700 *31,750	10 450 22,550	*11 500 *24,850	7650 16,450	8900 19,400	5900	8800 19,400	5850 12,900	9060 360
-1500 mm -60 in	kg lb	*15 000 *34,000	*15 000 *34,000	*18 550 *40,300	15 950 34,200	*14 150 *30,600	10 300 22,200	*11 050 *23,800	7550 16,250			*9150 *20,100	6300 13,900	8570 340
-3000 mm -120 in	kg lb	*20 700 *44,950	*20 700 *44,950	*16 250 *35,200	16 150 34,650	*12 600 *27,150	10 400 22,400	*9500 *20,200	7650 16,500			*8950 *19,700	7350 16,250	7750 310
-4500 mm -180 in	kg lb			*12 500 *26,700	*12 500 *26,700	*9450 *19,750	*9450 *19,750					*8250 *18,050	*8250 *18,050	6490 260

Mass Boom Lift Capacities – Counterweight: 9.0 mt (19,842 lb) – without Bucket

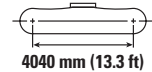
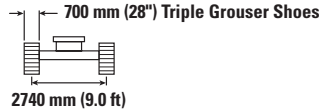
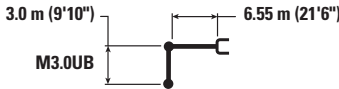

		3000 mm/120 in		4500 mm/180 in		6000 mm/240 in		7500 mm/300 in		9000 mm/360 in		mm in		
7500 mm 300 in	kg lb							*8400	*8400			*7900 *17,500	*7900 *17,500	7570 300
6000 mm 240 in	kg lb							*9500 *20,750	8900 19,100			*7650 *16,900	7200 16,050	8450 330
4500 mm 180 in	kg lb			*15 250 *32,750	*15 250 *32,750	*11 850 *25,600	*11 850 *25,600	*10 050 *21,850	8600 18,450			*7750 *17,000	6350 14,000	9000 360
3000 mm 120 in	kg lb			*18 400 *39,500	17 400 37,500	*13 300 *28,700	11 400 24,600	*10 750 *23,300	8200 17,600	9150 19,600	6150 13,200	*8050 *17,700	5850 12,900	9270 370
1500 mm 60 in	kg lb			*20 000 *43,250	16 250 34,950	*14 350 *31,050	10 750 23,200	*11 300 *24,500	7800 16,850	8950 19,200	5950 12,800	8500 18,750	5700 12,500	9290 370
0 mm 0 in	kg lb			*19 850 *43,050	15 800 34,000	*14 700 *31,750	10 350 22,300	*11 500 *24,750	7550 16,300	8800 19,200	5850	8750 19,200	5800 12,750	9060 360
-1500 mm -60 in	kg lb	*15 000 *34,000	*15 000 *34,000	*18 550 *40,300	15 800 33,900	*14 150 *30,600	10 200 22,000	*11 050 *23,800	7450 16,100			*9150 *20,100	6250 13,800	8570 340
-3000 mm -120 in	kg lb	*20 700 *44,950	*20 700 *44,950	*16 250 *35,200	16 000 34,350	*12 600 *27,150	10 300 22,200	*9500 *20,200	7550 16,350			*8950 *19,700	7250 16,100	7750 310
-4500 mm -180 in	kg lb			*12 500 *26,700	*12 500 *26,700	*9450 *19,750	*9450 *19,750					*8250 *18,050	*8250 *18,050	6490 260



ISO 10567



* Indicates that the load is limited by hydraulic lifting capacity rather than tipping load. The above loads are in compliance with hydraulic excavator lift capacity standard ISO 10567:2007. They do not exceed 87% of hydraulic lifting capacity or 75% of tipping load. Weight of all lifting accessories must be deducted from the above lifting capacities. Lifting capacities are based on the machine standing on a firm, uniform supporting surface. The use of a work tool attachment point to handle/lift objects, could affect the machine lift performance.

Lift capacity stays with ±5% for all available track shoes.

Always refer to the appropriate Operation and Maintenance Manual for specific product information.

345 GC Hydraulic Excavator Specifications

Mass Boom Lift Capacities – Counterweight: 9.0 mt (19,842 lb) – without Bucket

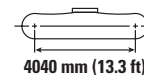
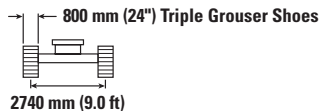
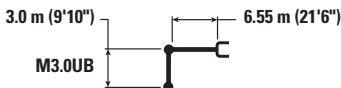

		3000 mm/120 in		4500 mm/180 in		6000 mm/240 in		7500 mm/300 in		9000 mm/360 in		mm in		
7500 mm 300 in	kg lb							*8400	*8400			*7900 *17,500	*7900 *17,500	7570 300
6000 mm 240 in	kg lb							*9500 *20,750	9000 19,350			*7650 *16,900	7300 16,250	8450 330
4500 mm 180 in	kg lb			*15 250 *32,750	*15 250 *32,750	*11 850 *25,600	*11 850 *25,600	*10 050 *21,850	8700 18,700			*7750 *17,000	6400 14,200	9000 360
3000 mm 120 in	kg lb			*18 400 *39,500	17 600 38,050	*13 300 *28,700	11 550 24,950	*10 750 *23,300	8300 17,850	*9250 19,900	6250 13,400	*8050 *17,700	5950 13,100	9270 370
1500 mm 60 in	kg lb			*20 000 *43,250	16 450 35,500	*14 350 *31,050	10 900 23,550	*11 300 *24,500	7950 17,100	9100 19,500	6050 13,050	8650 19,050	5800 12,700	9290 370
0 mm 0 in	kg lb			*19 850 *43,050	16 050 34,500	*14 700 *31,750	10 550 22,650	*11 500 *24,850	7700 16,550	8950 19,550	5950	8850 19,550	5900 12,950	9060 360
-1500 mm -60 in	kg lb	*15 000 *34,000	*15 000 *34,000	*18 550 *40,300	16 000 34,400	*14 150 *30,600	10 400 22,350	*11 050 *23,800	7600 16,350			*9150 *20,100	6350 14,000	8570 340
-3000 mm -120 in	kg lb	*20 700 *44,950	*20 700 *44,950	*16 250 *35,200	16 200 34,850	*12 600 *27,150	10 450 22,550	*9500 *20,200	7700 16,600			*8950 *19,700	7400 16,350	7750 310
-4500 mm -180 in	kg lb			*12 500 *26,700	*12 500 *26,700	*9450 *19,750	*9450					*8250 *18,050	*8250 *18,050	6490 260

Mass Boom Lift Capacities – Counterweight: 9.0 mt (19,842 lb) – without Bucket

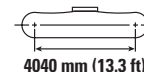
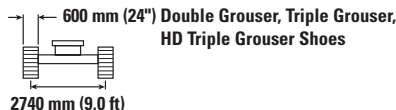
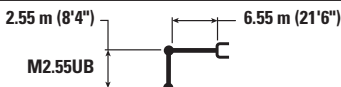

		3000 mm/120 in		4500 mm/180 in		6000 mm/240 in		7500 mm/300 in		mm in		
7500 mm 300 in	kg lb					*23,450	*23,450			*10 400 *23,000	10 100 22,800	7000 280
6000 mm 240 in	kg lb					*11 300 *24,550	*11 300 *24,550	*10 150 *22,200	8900 19,050	*9950 *22,000	8050 17,900	7950 310
4500 mm 180 in	kg lb			*16 500 *35,450	*16 500 *35,450	*12 550 *27,100	12 150 26,200	*10 600 *23,000	8600 18,500	*9800 *21,600	6950 15,450	8520 340
3000 mm 120 in	kg lb			*19 450 *41,850	17 150 37,000	*13 850 *29,950	11 400 24,600	*11 150 *24,200	8250 17,750	9550 21,050	6450 14,200	8810 350
1500 mm 60 in	kg lb			*36,200 35,050		*14 700 *31,850	10 850 23,350	*11 600 *25,100	7950 17,050	9350 20,550	6250 13,800	8830 350
0 mm 0 in	kg lb			*19 450 *42,350	16 100 34,600	*14 750 *31,950	10 550 22,700	*11 550 *25,000	7750 16,650	9600 21,200	6400 14,100	8590 340
-1500 mm -60 in	kg lb	*15 050 *34,350	*15 050 *34,350	*17 800 *38,750	16 150 34,700	*13 900 *30,100	10 450 22,550	*10 800 *23,250	7700 16,550	*9650 *21,300	7000 15,450	8070 320
-3000 mm -120 in	kg lb	*18 000 *39,300	*18 000 *39,300	*15 200 *32,900	*15 200 *32,900	*11 950 *25,700	10 600 22,900			*9300 *20,450	8300 18,450	7190 290
-4500 mm -180 in	kg lb			*10 800	*10 800					*8100 *18,300	*8100 *18,300	5810 220



ISO 10567



* Indicates that the load is limited by hydraulic lifting capacity rather than tipping load. The above loads are in compliance with hydraulic excavator lift capacity standard ISO 10567:2007. They do not exceed 87% of hydraulic lifting capacity or 75% of tipping load. Weight of all lifting accessories must be deducted from the above lifting capacities. Lifting capacities are based on the machine standing on a firm, uniform supporting surface. The use of a work tool attachment point to handle/lift objects, could affect the machine lift performance.

Lift capacity stays with ±5% for all available track shoes.

Always refer to the appropriate Operation and Maintenance Manual for specific product information.

345 GC Hydraulic Excavator Specifications

Mass Boom Lift Capacities – Counterweight: 9.0 mt (19,842 lb) – without Bucket

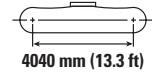
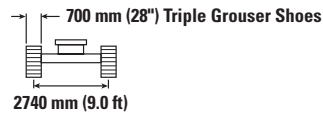
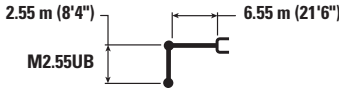

Boom Length mm in	kg lb	3000 mm/120 in		4500 mm/180 in		6000 mm/240 in		7500 mm/300 in		mm in		
7500 mm 300 in	kg lb					*23,450	*23,450			*10 400 *23,000	10 000 22,600	7000 280
6000 mm 240 in	kg lb					*11 300 *24,550	*11 300 *24,550	*10 150 *22,200	8800 18,900	*9950 *22,000	7950 17,700	7950 310
4500 mm 180 in	kg lb			*16 500 *35,450	*16 500 *35,450	*12 550 *27,100	12 050 25,950	*10 600 *23,000	8550 18,350	*9800 *21,600	6900 15,300	8520 340
3000 mm 120 in	kg lb			*19 450 *41,850	17 000 36,700	*13 850 *29,950	11 300 24,400	*11 150 *24,200	8150 17,600	9450 20,850	6400 14,050	8810 350
1500 mm 60 in	kg lb			*36,200	34,750	*14 700 *31,850	10 750 23,150	*11 600 *25,100	7850 16,900	9250 20,350	6200 13,650	8830 350
0 mm 0 in	kg lb			*19 450 *42,350	15 950 34,250	*14 750 *31,950	10 450 22,450	*11 550 24,950	7650 16,450	9550 21,000	6350 14,000	8590 340
-1500 mm -60 in	kg lb	*15 050 *34,350	*15 050 *34,350	*17 800 *38,750	16 000 34,400	*13 900 *30,100	10 350 22,300	*10 800 *23,250	7600 16,400	*9650 *21,300	6950 15,300	8070 320
-3000 mm -120 in	kg lb	*18 000 *39,300	*18 000 *39,300	*15 200 *32,900	*15 200 *32,900	*11 950 *25,700	10 500 22,650			*9300 *20,450	8250 18,300	7190 290
-4500 mm -180 in	kg lb			*10 800	*10 800					*8100 *18,300	*8100 *18,300	5810 220

Mass Boom Lift Capacities – Counterweight: 9.0 mt (19,842 lb) – without Bucket

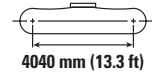
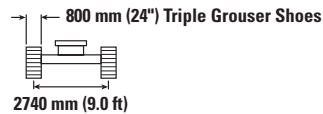
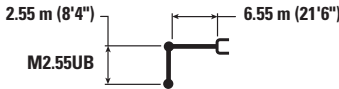

Boom Length mm in	kg lb	3000 mm/120 in		4500 mm/180 in		6000 mm/240 in		7500 mm/300 in		mm in		
7500 mm 300 in	kg lb					*23,450	*23,450			*10 400 *23,000	10 150 22,900	7000 280
6000 mm 240 in	kg lb					*11 300 *24,550	*11 300 *24,550	*10 150 *22,200	8950 19,150	*9950 *22,000	8050 17,950	7950 310
4500 mm 180 in	kg lb			*16 500 *35,450	*16 500 *35,450	*12 550 *27,100	12 200 26,300	*10 600 *23,000	8650 18,600	*9800 *21,600	7000 15,500	8520 340
3000 mm 120 in	kg lb			*19 450 *41,850	17 200 37,200	*13 850 *29,950	11 450 24,750	*11 150 *24,200	8300 17,850	9600 21,150	6500 14,250	8810 350
1500 mm 60 in	kg lb			*36,200	35,250	*14 700 *31,850	10 900 23,500	*11 600 *25,100	7950 17,150	9400 20,700	6300 13,850	8830 350
0 mm 0 in	kg lb			*19 450 *42,350	16 200 34,800	*14 750 *31,950	10 600 22,800	*11 550 *25,000	7750 16,750	9700 21,300	6450 14,200	8590 340
-1500 mm -60 in	kg lb	*15 050 *34,350	*15 050 *34,350	*17 800 *38,750	16 250 34,900	*13 900 *30,100	10 550 22,650	*10 800 *23,250	7750 16,650	*9650 *21,300	7050 15,500	8070 320
-3000 mm -120 in	kg lb	*18 000 *39,300	*18 000 *39,300	*15 200 *32,900	*15 200 *32,900	*11 950 *25,700	10 700 23,000			*9300 *20,450	8350 18,550	7190 290
-4500 mm -180 in	kg lb			*10 800	*10 800					*8100 *18,300	*8100 *18,300	5810 220



ISO 10567



* Indicates that the load is limited by hydraulic lifting capacity rather than tipping load. The above loads are in compliance with hydraulic excavator lift capacity standard ISO 10567:2007. They do not exceed 87% of hydraulic lifting capacity or 75% of tipping load. Weight of all lifting accessories must be deducted from the above lifting capacities. Lifting capacities are based on the machine standing on a firm, uniform supporting surface. The use of a work tool attachment point to handle/lift objects, could affect the machine lift performance.

Lift capacity stays with ±5% for all available track shoes.

Always refer to the appropriate Operation and Maintenance Manual for specific product information.

345 GC Hydraulic Excavator Specifications

Bucket Specifications and Compatibility – Africa, Middle East and CIS

	Linkage	Width		Capacity		Weight		Fill %	9.0 mt (19,842 lb) Counterweight			
		mm	in	m ³	yd ³	kg	lb		Reach Boom		Mass Boom	
									R2.9 (9'6")	R3.35 (11'0")	M2.55 (8'4")	M3.0 (9'10")
Pin-On (No Quick Coupler)												
Heavy Duty (HD)	TB	1350	54	1.87	2.44	1979	4,363	100	●	●		
	TB	1650	66	2.41	3.15	2220	4,894	100	⊖	⊖		
	TB	1850	72	2.60	3.40	2349	5,179	100	⊖	○		
	TB	1850	72	2.69	3.52	2349	5,179	100	⊖	○		
	TB	1900	74	2.78	3.64	2427	5,350	100	X	X		
Severe Duty (SD)	TB	1400	55	1.87	2.44	2170	4,783	90	●	●		
	TB	1550	61	2.14	2.80	2327	5,129	90	●	⊙		
	TB	1900	75	2.78	3.64	2683	5,914	90	X	X		
Severe Duty (SD) – V edge	TB	1700	67	2.41	3.16	2479	5,464	90	⊙	⊖		
Extreme Duty (XD)	TB	1700	67	2.41	3.16	2722	6,000	90	⊖	○		
General Duty (GD)	UB	2000	79	3.60	4.71	2890	6,371	100			◇	◇
Heavy Duty (HD)	UB	1650	65	2.77	3.62	2573	5,672	100			⊖	○
	UB	1850	73	3.21	4.20	2758	6,079	100			○	◇
	UB	1950	77	3.43	4.48	2912	6,419	100			◇	◇
Severe Duty (SD)	UB	1550	61	2.61	3.41	2658	5,859	90			⊙	⊖
	UB	1600	64	2.70	3.53	2725	6,007	90			⊖	○
	UB	1650	65	2.77	3.62	2738	6,035	90			⊖	○
	UB	1850	73	3.21	4.20	2972	6,552	90			○	◇
	UB	1950	77	3.43	4.48	3106	6,847	90			○	◇
Maximum load with pin-on (payload + bucket)								kg	6215	5785	6680	6025
								lb	13,702	12,754	14,727	13,283
Pin-On (No Quick Coupler)												
HD	TB	1900	74	2.78	3.64	2427	5,350	90	92%	92%		
SD	TB	1900	75	2.78	3.64	2683	5,914	92	97%	97%		

The above loads are in compliance with hydraulic excavator standard EN474-5:2006+A3:2013, they do not exceed 87% of hydraulic lifting capacity or 75% of tipping capacity with front linkage fully extended at ground line with bucket curled.

Capacity based on ISO 7451:2007.

Bucket weight with Long tips.

Maximum Material Density:

- 2100 kg/m³ (3,500 lb/yd³)
- ⊙ 1800 kg/m³ (3,000 lb/yd³)
- ⊖ 1500 kg/m³ (2,500 lb/yd³)
- 1200 kg/m³ (2,000 lb/yd³)
- ◇ 900 kg/m³ (1,500 lb/yd³)

Caterpillar recommends using appropriate work tools to maximize the value customers receive from our products. Use of work tools, including buckets, which are outside of Caterpillar's recommendations or specifications for weight, dimensions, flows, pressures, etc. may result in less-than-optimal performance, including but not limited to reductions in production, stability, reliability, and component durability. Improper use of a work tool resulting in sweeping, prying, twisting and/or catching of heavy loads will reduce the life of the boom and stick.

345 GC Hydraulic Excavator Specifications

Bucket Specifications and Compatibility – Southeast Asia

	Linkage	Width		Capacity		Weight		Fill %	9.0 mt (19,842 lb) Counterweight			
		mm	in	m ³	yd ³	kg	lb		Reach Boom		Mass Boom	
									R2.9 (9'6")	R3.35 (11'0")	M2.55 (8'4")	M3.0 (9'10")
Pin-On (No Quick Coupler)												
Heavy Duty	TB	1200	48	1.60	2.09	1852	4,083	100	●	●		
	TB	1350	54	1.87	2.44	1979	4,363	100	●	●		
	TB	1500	60	2.14	2.80	2143	4,724	100	⊙	⊖		
	TB	1650	66	2.41	3.15	2307	5,086	100	⊖	⊖		
	TB	1800	72	2.69	3.52	2437	5,373	100	○	○		
	TB	1850	73	2.69	3.52	2527	5,571	100	○	○		
Severe Duty	TB	1400	55	1.87	2.44	2170	4,783	90	●	●		
	TB	1550	61	2.14	2.80	2369	5,222	90	●	⊙		
	TB	1700	67	2.41	3.16	2509	5,531	90	⊖	⊖		
	TB	1550	61	2.14	2.80	2254	4,968	90	●	⊙		
General Duty	UB	2000	79	3.60	4.71	2890	6,371	100			◇	◇
Heavy Duty	UB	1500	61	2.50	3.27	2455	5,411	100			⊖	⊖
	UB	1650	65	2.77	3.62	2573	5,672	100			⊖	○
	UB	1750	70	3.00	3.92	2670	5,885	100			○	◇
	UB	1850	73	3.21	4.20	2758	6,079	100			○	◇
	UB	1950	77	3.43	4.48	2912	6,419	100			◇	◇
Maximum load with pin-on (payload + bucket)								kg	6215	5785	6680	6025
								lb	13,702	12,754	14,727	13,283
Pin-On (No Quick Coupler)												
HD	TB	1900	74	2.78	3.64	2427	5,350	90	92%	92%		
SD	TB	1900	75	2.78	3.64	2683	5,914	92	97%	97%		

The above loads are in compliance with hydraulic excavator standard EN474-5:2006+A3:2013, they do not exceed 87% of hydraulic lifting capacity or 75% of tipping capacity with front linkage fully extended at ground line with bucket curled.

Capacity based on ISO 7451:2007.

Bucket weight with Long tips.

Maximum Material Density:

- 2100 kg/m³ (3,500 lb/yd³)
- ⊙ 1800 kg/m³ (3,000 lb/yd³)
- ⊖ 1500 kg/m³ (2,500 lb/yd³)
- 1200 kg/m³ (2,000 lb/yd³)
- ◇ 900 kg/m³ (1,500 lb/yd³)

Caterpillar recommends using appropriate work tools to maximize the value customers receive from our products. Use of work tools, including buckets, which are outside of Caterpillar's recommendations or specifications for weight, dimensions, flows, pressures, etc. may result in less-than-optimal performance, including but not limited to reductions in production, stability, reliability, and component durability. Improper use of a work tool resulting in sweeping, prying, twisting and/or catching of heavy loads will reduce the life of the boom and stick.

345 GC Hydraulic Excavator Specifications

Attachments Offering Guide – Africa, Middle East and CIS

Not all Attachments are available in all regions. Consult your Cat dealer for configurations available in your region.

Match

* Working range front only

No Match

PIN-ON ATTACHMENTS

Counterweight		9.0 mt (19,842 lb)			
		Reach	Reach	ME	ME
Boom Type					
Stick Size		2.9m (9'6")	3.35m (11'0")	2.5m (8'2")	3.0m (9'10")
Hydraulic Hammers	H140 GC	✓	✓		
	H140 GC S	✓	✓		
	H160 GC	✓	✓	✓	✓
	H160 GC S	✓	✓	✓	✓
	H160 S			✓	✓
	H180 GC	✓	✓	✓	✓
	H180 GC S	✓	✓	✓	✓
	H180 S			✓	✓
Multi-Processors	MP332 Concrete Cutter Jaw				
	MP332 Demolition Jaw				
	MP332 Pulverizer Jaw				
	MP332 Shear Jaw				
	MP332 Tank Shear Jaw				
	MP332 Universal Jaw				
	MP345 Concrete Cutter Jaw			✓	✓
	MP345 Demolition Jaw			✓	✓
	MP345 Pulverizer Jaw			✓	✓
	MP345 Shear Jaw			✓	✓
Demolition and Sorting Grapples	G345			✓	✓
Mobile Scrap and Demolition Shears	S3050			✓	✓*
	S3050 Flat Top			✓*	
Pulverizers	P235			✓	✓
Crushers	P335			✓	✓
Orange Peel Grapples	GSH455-1000				
	GSH455-1500				
	GSH455-2000				
	GSH555-1000				
	GSH555-1500				
	GSM-50-1250				
	GSM-50-1500				
	GSM-50-2000				
Hydraulic Transfer Grab	CTV30-1700				
	CTV30-1900				
	CTV30-2300				
	CTV30-2700				

345 GC Hydraulic Excavator Specifications

Attachments Offering Guide – Africa, Middle East and CIS (continued)

Not all Attachments are available in all regions. Consult your Cat dealer for configurations available in your region.

Match

* Working range front only

No Match

CAT PIN GRABBER COUPLER ATTACHMENTS

Counterweight		9.0 mt (19,842 lb)			
Boom Type		Reach	Reach	ME	ME
Stick Size		2.9m (9'6")	3.35m (11'0")	2.5m (8'2")	3.0m (9'10")
Hydraulic Hammers	H140 GC	✓	✓		
	H140 GC S	✓	✓		
	H160 GC	✓	✓	✓	✓
	H160 GC S	✓	✓	✓	✓
	H180 GC	✓*		✓*	
	H180 GC S	✓	✓	✓	✓*

CW-55 DEDICATED COUPLER ATTACHMENTS

Counterweight		9.0 mt (19,842 lb)			
Boom Type		Reach	Reach	ME	ME
Stick Size		2.9m (9'6")	3.35m (11'0")	2.5m (8'2")	3.0m (9'10")
Hydraulic Hammers	H140 GC S	✓	✓		
	H160 GC	✓	✓		
	H160 GC S	✓	✓		
	H160 S			✓	✓
	H180 S			✓	✓*
	H180 GC			✓	
	H180 GC S			✓	✓*
	Multi-Processors	MP332 Concrete Cutter Jaw			
MP332 Demolition Jaw					
MP332 Pulverizer Jaw					
MP332 Shear Jaw					
MP332 Tank Shear Jaw					
MP332 Universal Jaw					
MP345 Concrete Cutter Jaw				✓*	
MP345 Demolition Jaw				✓*	
MP345 Pulverizer Jaw				✓*	
MP345 Shear Jaw				✓*	
Demolition and Sorting Grapples	G345			✓	✓
Pulverizers	P235			✓	✓
Crushers	P335			✓	✓

BOOM-MOUNT ATTACHMENTS

Counterweight		9.0 mt (19,842 lb)	
Boom Type		ME	
Mobile Scrap and Demolition Shears	S2090	✓	
	S3070	✓	
	S3090	✓	

345 GC Hydraulic Excavator Specifications

Attachments Offering Guide – Southeast Asia

Not all Attachments are available in all regions. Consult your Cat dealer for configurations available in your region.

Match

No Match

PIN-ON ATTACHMENTS

Counterweight		9.0 mt (19,842 lb)			
		Reach	Reach	ME	ME
Boom Type		2.9m (9'6")	3.35m (11'0")	2.5m (8'2")	3.0m (9'10")
Stick Size					
Hydraulic Hammers	H140 GC	✓	✓		
	H140 GC S	✓	✓		
	H160 GC	✓	✓	✓	✓
	H160 GC S	✓	✓	✓	✓
	H160 S			✓	✓
	H180 GC	✓	✓	✓	✓
	H180 GC S	✓	✓	✓	✓
	H180 S			✓	✓

345 GC Standard and Optional Equipment

Standard and Optional Equipment

Standard and optional equipment may vary. Consult your Cat dealer for details.

	Standard	Optional		Standard	Optional
BOOMS AND STICKS			HYDRAULIC SYSTEM		
6.9 m (22'8") Reach boom		✓	Boom and stick regeneration circuit	✓	
6.55 m (21'6") Mass boom		✓	Electronic main control valve	✓	
2.9 m (9'6") Reach stick		✓	Automatic hydraulic oil warmup	✓	
3.35 m (11'0") Reach stick		✓	Reverse swing damping valve	✓	
2.55 m (8'4") Mass stick		✓	Automatic swing parking brake	✓	
3.0 m (9'10") Mass stick		✓	High performance hydraulic return filter	✓	
CAB			Two speed travel	✓	
ROPS	✓		Bio hydraulic oil capability	✓	
High-resolution 203 mm (8 in) LCD touchscreen monitor	✓		Fine swing (depending on region)		✓
Automatic bi-level air conditioner	✓		Combined two-way auxiliary circuit		✓
Jog dial and shortcut keys for monitor control	✓		Combined two-way auxiliary circuit with hammer return filter		✓
Keyless push-to-start engine control	✓		SAFETY AND SECURITY		
Height-adjustable console, three steps with tool	✓		Caterpillar One Key security system	✓	
Mechanically adjustable seat suspension	✓		Lockable external tool/storage box	✓	
51 mm (2 in) seat belt	✓		Lockable door, fuel, and hydraulic tank locks	✓	
Fixed left-side console	✓		Lockable fuel drain compartment	✓	
Bluetooth integrated radio with USB ports	✓		Service platform with anti-skid plate and recessed bolts	✓	
12V DC outlets (×2)	✓		RH handrail and handhold (ISO 2867:2011 compliant)	✓	
Document storage	✓		Standard visibility mirror package	✓	
Cup and bottle holders	✓		Signaling/warning horn	✓	
Openable two-piece front window	✓		Ground-level secondary engine shutoff switch	✓	
Upper radial wiper with 70/30 with washer	✓		Rearview camera and right-hand-side mirror	✓	
Openable steel hatch	✓		Right-hand-side camera (depending on region)		✓
LED dome and lower interior lights	✓		Travel alarm		✓
Roller front sunscreen	✓		SERVICE AND MAINTENANCE		
CAT TECHNOLOGY			Grouped location of engine oil and fuel filters	✓	
Cat Product Link™	✓		Scheduled Oil Sampling (S·O·S SM) sampling ports	✓	
Auto hammer stop	✓		Electric refueling pump with automatic shutoff		✓
ELECTRICAL SYSTEM			UNDERCARRIAGE AND STRUCTURES		
Maintenance-free 1,000 CCA batteries (×2)	✓		Towing eye on base frame	✓	
Maintenance-free 1,000 CCA batteries (×4) for -32° C (-25° F) cold start capability		✓	9 mt (19,842 lb) counterweight	✓	
Centralized electrical disconnect switch	✓		600 mm (24") triple grouser track shoes		✓
LED chassis light, LH boom lights, cab lights	✓		600 mm (24") HD triple grouser track shoes		✓
Premium surrounding light package		✓	600 mm (24") double grouser track shoes		✓
ENGINE			700 mm (28") triple grouser track shoes		✓
Cold start block heater		✓	800 mm (31") triple grouser track shoes		✓
Two selectable modes: Power, Smart	✓				
Automatic engine speed control	✓				
2300 m (7,550 ft) altitude capability with no engine power de-rating	✓				
52° C (126° F) high-ambient cooling capacity	✓				
Hydraulic reverse fan		✓			
-18° C (0° F) cold start capability	✓				
-32° C (-25° F) cold start capability		✓			
Double element air filter with integrated precleaner	✓				
Remote disable (depending on region and VisionLink® subscription)	✓				

Dealer Installed Kit and Attachments

Attachments may vary. Consult your Cat dealer for details.

- | | | |
|---|--|---|
| CAB <ul style="list-style-type: none">• Lower radial wiper• Polycarbonate hatch• LH/RH electrical pedal for tool control | SAFETY AND SECURITY <ul style="list-style-type: none">• Bluetooth® receiver• Bluetooth key fob | GUARDS <ul style="list-style-type: none">• Falling object guard system• Mesh guard full front• Mesh guard lower half front• Full protecting vandalism guard |
|---|--|---|

For more complete information on Cat products, dealer services, and industry solutions, visit us on the web at www.cat.com

© 2021 Caterpillar
All rights reserved

Materials and specifications are subject to change without notice. Featured machines in photos may include additional equipment. See your Cat dealer for available options.

CAT, CATERPILLAR, LET'S DO THE WORK, their respective logos, "Caterpillar Corporate Yellow," the "Power Edge" and Cat "Modern Hex" trade dress as well as corporate and product identity used herein, are trademarks of Caterpillar and may not be used without permission.

VisionLink is a trademark of Trimble Navigation Limited, registered in the United States and in other countries.

AEXQ2488-04 (09-2021)
Replaces AEXQ2488-03
Build Number: 07D
(Afr-ME, CIS, SE Asia)

