

KOMATSU®

PC800/800LC-8R1 BACKHOE PC800LC-8R1 LOADING SHOVEL

PC
800

HORSEPOWER

Gross: 370 kW 496 HP / 1800 min⁻¹

Net: 363 kW 487 HP / 1800 min⁻¹

OPERATING WEIGHT

Backhoe: 74500 – 79900 kg

Loading shovel: 77300 kg

BUCKET CAPACITY

Backhoe: 2.80 – 4.00 m³

Loading shovel: 4.50 m³, 5.10 m³



Photos may include optional equipment.

WALK-AROUND



Photos may include optional equipment.



PRODUCTIVITY, ECOLOGY & ECONOMY

- High Power Komatsu SAA6D140E-5 Engine
- Economy Mode Four-level Setting
- Low Ambient Noise
- Working Mode Selection
- Heavy Lift Mode
- Swing Priority Mode
- Large Digging Force
- High Work Equipment Speed
- Large Drawbar Pull and Steering Force
- Two-mode Setting for Boom
- Shockless Boom Control

RELIABILITY & DURABILITY

- Boom Foot Hoses
- O-ring Face Seals
- Removed Water and Contamination in Fuel
- High-pressure In-line Filtration
- Highly Reliable Electronic Devices
- KMAX Bucket Teeth

COMFORT & SAFETY

- Large Comfortable Cab
- OPG Top Guard Level 2 (ISO 10262) (Optional)
- Rear View Monitor System (Optional)

* Information and Communication Technology

ICT* & KOMTRAX

- Large Liquid Crystal Display (LCD) Monitor
- Equipment Management Monitoring System
- KOMTRAX

MAINTENANCE

- Easy Checking and Maintenance of Engine
- Easy Cleaning of Cooling Unit
- Large Handrail, Step and Catwalk

	PC800/800LC-8R1 BACKHOE	PC800LC-8R1 LOADING SHOVEL
HORSEPOWER	Gross: 370 kW 496 HP / 1800 min ⁻¹	370 kW 496 HP / 1800 min ⁻¹
	Net: 363 kW 487 HP / 1800 min ⁻¹	363 kW 487 HP / 1800 min ⁻¹
OPERATING WEIGHT	74500 – 79900 kg	77300 kg
BUCKET CAPACITY	2.80 – 4.00 m ³	4.50 m ³ , 5.10 m ³

PRODUCTIVITY, ECOLOGY & ECONOMY

Komatsu Technology

Komatsu develops and produces all major components, such as engines, electronics and hydraulic components, in house. With this “Komatsu Technology,” and adding customer feedback, Komatsu is achieving great advancements in technology. To achieve both high levels of productivity and economical performance, Komatsu has developed the main components with a total control system. The result is a new generation of high performance and environment friendly excavators.

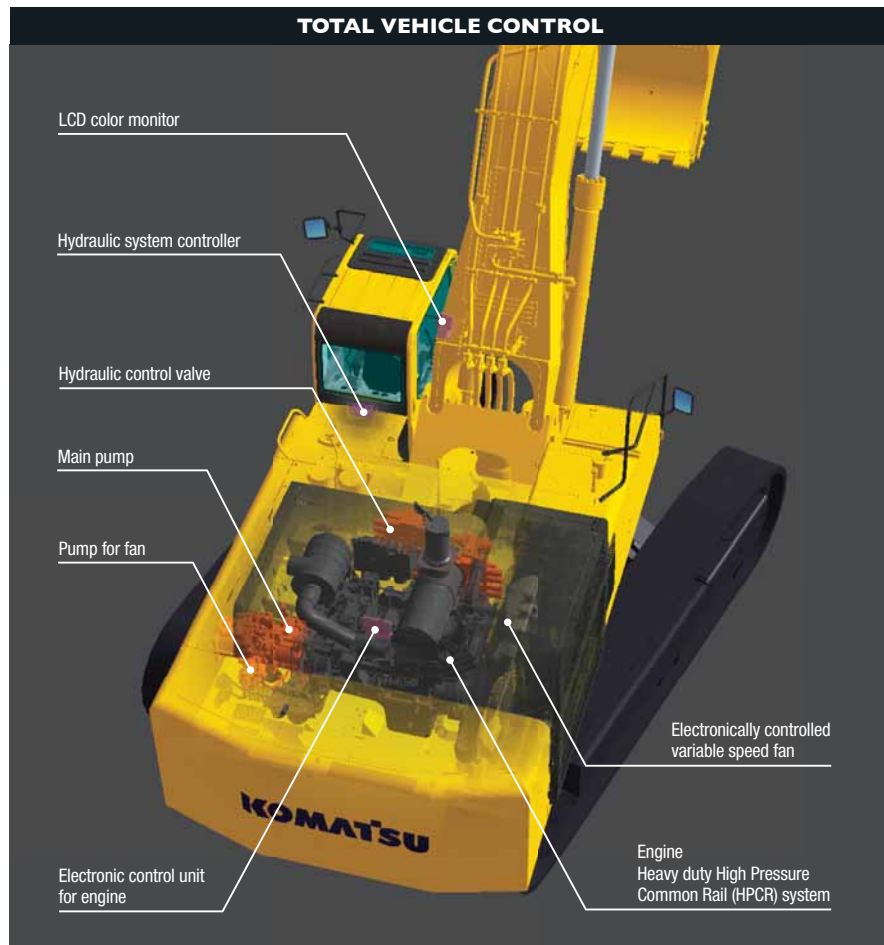
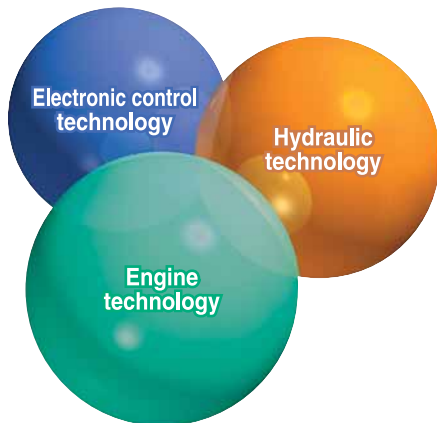

High Power Komatsu SAA6D140E-5 Engine

Powerful turbocharged and air-to-air aftercooled Komatsu SAA6D140E-5 engine provides 363 kW 487 HP. This Komatsu SAA6D140E-5 engine is U.S. EPA Tier 2 and EU Stage 2 emissions equivalent. This Komatsu SAA6D140E-5 engine actualizes high-power to low fuel consumption with the optimum fuel injection by electronic heavy duty High Pressure Common Rail (HPCR) fuel injection system.



Electronically Controlled Variable Speed Fan Contributes to Low Fuel Consumption and Low Noise

The electronic control system sets the revolution speed of the cooling fan according to the coolant, hydraulic oil, and ambient temperature; effectively uses the engine output to prevent wasteful fuel consumption; and reduces noise during low-speed fan revolution.

Lower and Economical Fuel Consumption Using Economy Mode

Enables operator to set the Economy mode to four levels according to working conditions so that production requirement is achieved at the lowest fuel consumption.



Low Ambient Noise

Reduced noise by adoption of an electronically controlled variable speed fan drive, large hybrid fan and low-noise muffler.

ECO gauge that Assists Energy-saving Operations

ECO gauge is equipped for environment friendly energy-saving operations. Operation in the green range allows reduction of CO₂ emission and fuel consumption.



ECO gauge

Idling Caution

To prevent unnecessary fuel consumption, an idling caution is displayed on the monitor if the engine idles for 5 minutes or more.



Auto Deceleration and Auto Idling System

Auto deceleration system is equipped to reduce fuel consumption and operating noise. Also, engine idling speed can be reduced on the monitor with the auto idling system.

Working Modes Selectable

P and E modes established work modes are further improved.

P mode – Power or work priority mode has low fuel consumption, but fast equipment speed and maximum production and power are maintained.

E mode – Economy or fuel saving mode further reduces fuel consumption, but maintains the P-mode-like working equipment speed for light duty work.

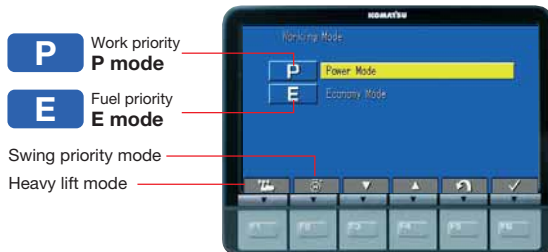

You can select Power or Economy modes using a one-touch button on the monitor panel depending on the workload.

Heavy Lift Mode

Gives 10% more lifting force when needed for handling rock or heavy lifting applications.

Swing Priority Mode

The swing priority mode allows the operator to use the same easy motion for 180° loading as 90° loading operations. By altering the oil flow, this setting allows you to select either boom or swing as the priority for increased production.

Selection	Result
ON	Oil flow to the swing motor is increased. 180° loading operations are most efficient.
OFF	Oil flow to the boom is increased. 90° loading operations are most efficient.

Large Digging Force

With the one-touch Power Max. function digging force is further increased. (approx. 8.5 seconds of operation)

Maximum arm crowd force (ISO 6015):
250 kN (25.5 t) ➔ **273 kN (27.9 t)** **9.4% UP**
(With Power Max.)

Maximum bucket digging force (ISO 6015):
333 kN (34.0 t) ➔ **364 kN (37.2 t)** **9.4% UP**
(With Power Max.)

Measured with Power Max. function, 3600 mm arm and ISO 6015 rating.

Work Equipment Speed

An arm quick return circuit is provided for arm dumping. This returns a portion of oil flow directly to the hydraulic tank at arm dumping to reduce the hydraulic pressure loss. Speedier loading work can be accomplished by work equipment with quicker movement.



Large Drawbar Pull and Steering Force

Since the machine has a large drawbar pull and a high steering force, it demonstrates excellent mobility even when it is on inclined sites.

Two-mode Setting for Boom

Smooth mode provides easy operation for gathering blasted rock and scraping operations. When maximum digging force is needed, switch to power mode for more effective excavating.

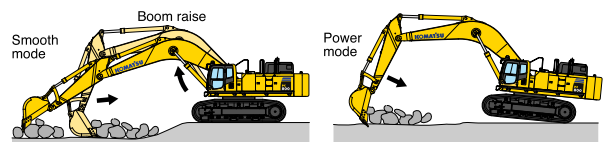

Shockless Boom Control

The PC800-8R1 boom circuit features a shockless valve (Double-check slow return valve) to automatically reduces the amount of vibration present when operating the boom. Operator fatigue is reduced (Which can improve safety and productivity), and spillage caused by vibration is minimized.

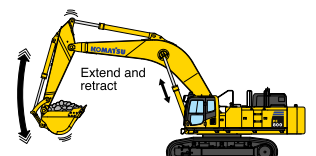

RELIABILITY & DURABILITY

Boom Foot Hoses

The boom foot hoses are arranged under the boom foot to reduce hose bend during operation, extending hose life and improving operator safety.



Frame Structure

The revolving frame mount and center frame mount on the swing circle are no welding structure so that force is transmitted directly to the thick plate of the frame without passing through any welding.

O-ring Face Seal

The hydraulic hose seal method has been changed from a conventional taper seal to an O-ring seal. This provides improved sealing performance during operation.

Fuel Pre-filter (With Water Separator)

Removes water and contaminants from fuel to enhance the fuel system reliability.



High Efficiency Fuel Filter

Fuel system reliability is even better with high efficiency fuel filter.



High-pressure In-line Filtration

The PC800-8R1 has the most extensive filtration system available, providing in-line filters as standard equipment. An in-line filter in the outlet port of each main hydraulic pump reduces failures caused by contamination.



Metal Guard Rings

Metal guard rings protect all the hydraulic cylinders and improve reliability.

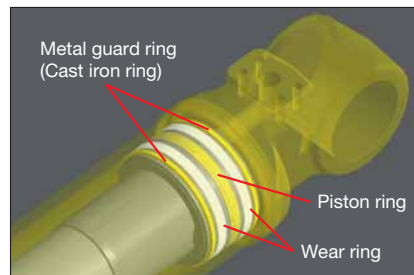

Heat-resistant Wiring

Heat-resistant wiring is utilized for the engine electric circuit and other major component circuit.

Water Separator

Removes water from the fuel and improves the reliability of fuel systems.



Sturdy Undercarriage

The undercarriage is strengthened to provide excellent reliability and durability when working on rocky ground or blasted rock.



Sturdy guards shield the travel motors and piping against damage from rocks.



Full length track roller guard (Optional)

Sealed Connectors

Sealed connectors seal tight and have higher reliability.

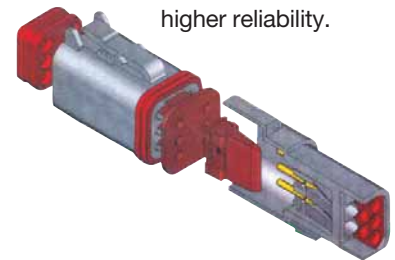

Circuit Breaker

With circuit breaker, the machine can be easily restarted after repair.



Strengthened Quarry Bucket Provides Outstanding Wear-resistance (Optional for SE Spec.)

The PC800-8R1 has the bucket for specific use in quarry, this is strong in impact and wear, and providing high performance and long life. Komatsu KVV's hard materials* provide excellent wear resistance. Combined with adoption of long-life KMAX teeth, durability of bucket is drastically enhanced.

* Komatsu KVV's hard materials: Komatsu KVV developed, wear-resistant, reinforced materials. Brinell hardness: 500 or more (180 kg/mm² class). Features high wear-resistance and little quality change from the heat generated during rock loading, maintaining long term hardness.

KMAX Tooth

- Unique bucket tooth shape for superior digging performance
- Long-term high sharpness
- Great penetration performance
- Hammerless, safe, and easy tooth replacement (Tooth replacement time: Half of the conventional machine.)

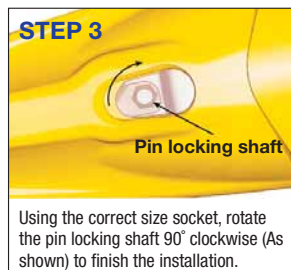
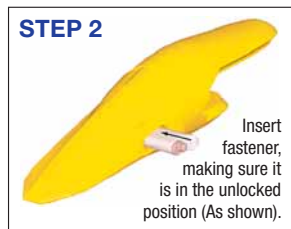
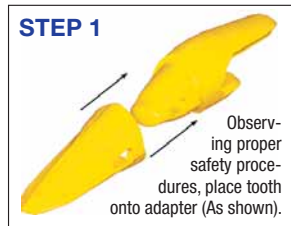
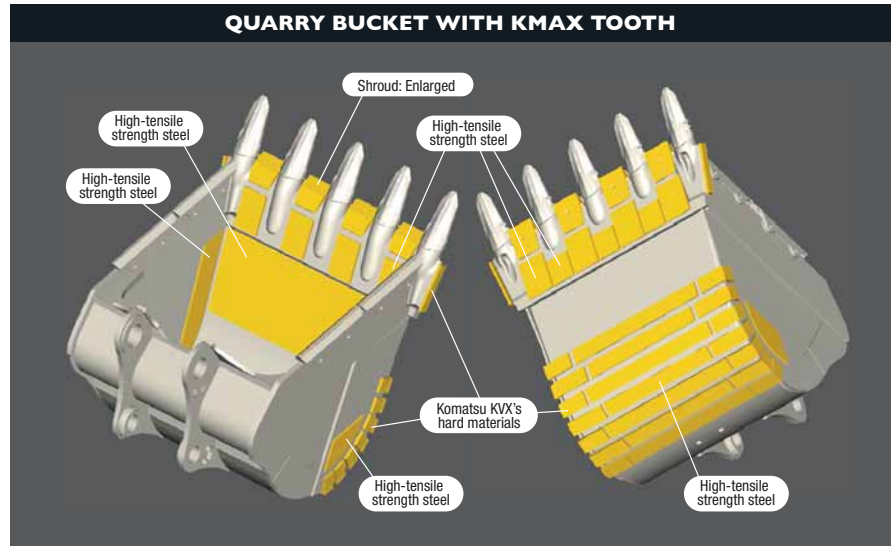

Photo may include optional equipment.



COMFORT



Wide Newly-designed Cab

Newly-designed wide spacious cab includes seat with reclining backrest. The seat height and longitudinal inclination are easily adjusted using a pull-up lever. You can set the appropriate operational position of the armrest and the console. The reclining seat further enables you to place it into the fully flat state with the headrest attached.



Seat with headrest reclined full flat

Low Noise Design Cab

The newly-designed cab is highly rigid and has excellent sound absorption. Improvements in noise source reduction combined with the use of a low noise engine, hydraulic equipment, and air conditioner allows the operator to work in quiet operating condition.

Operator ear's noise

2 dB(A) reduced

Compared with the current model

Pressurized Cab

Optional air conditioner, air filter and a higher internal air pressure minimize external dust from entering the cab.

Multi-position Controls

The multi-position, Pressure Proportional Control (PPC) levers allow the operator to work in comfort while maintaining precise control. A double-slide mechanism allows the seat and control levers to move together or independently, allowing the operator to position the controls for maximum productivity and comfort.



Seat sliding amount: 340 mm

Low Vibration with Cab Damper Mounting

PC800-8R1 uses viscous damper mounts for the cab that incorporates longer stroke and the addition of a spring. The cab damper mounting combined with high rigidity deck aids vibration reduction at the operator's seat.

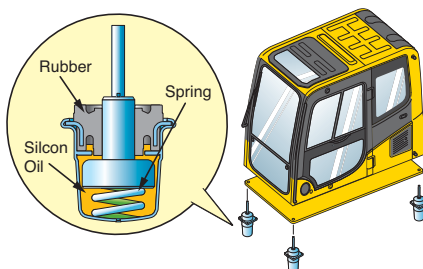

Automatic Air Conditioner (A/C) (Optional)

Enables you to easily and precisely set cab atmosphere with the instruments on the large LCD. The automatic air conditioner uses a bi-level control function that keeps the operator's head and feet cool and warm respectively. This improved air flow function keeps the inside of the cab comfortable throughout the year.



Defroster function keeps the front glass clear.

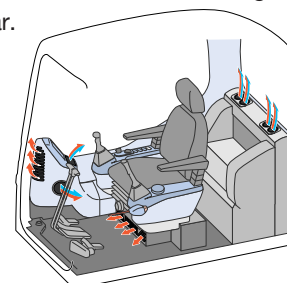

Cab Equipments



Skylight



Sliding Window and Large Side Mirror



Defroster (Optional)



Cab Frame Mounted Wiper



Bottle Holder and Magazine Rack

SAFETY

Step Light with Timer

Provides light for about one minute to allow the operator to get off the machine safely.



Horn Interconnected with Warning Light (Optional)

Gives visual and audible notice of the excavator's operation when activated.



Rear View Monitor System (Optional)

The operator can view the rear of the machine with a color monitor screen.



Pump/engine Room Partition

Prevents oil from spraying on the engine if a hydraulic hose should burst.



Thermal and Fan Guards

Are placed around high-temperature parts of the engine and fan drive.

Slip-resistant Plates

Spiked plates on working areas provide slip-resistant performance.

LARGE LCD COLOR MONITOR



Basic operation switches

Function switches

A/C operation switches

Large Multi-lingual LCD Monitor

A large user-friendly color monitor enables safe, accurate and smooth work. Improved screen visibility is achieved by the use of LCD that can easily be read at various angles and lighting conditions. The switches are simple and easy to operate. Function keys facilitate multi-function operations. Displays data in 12 languages to support operators around the world.

Indicators

- 1 Auto-decelerator
- 2 Working mode
- 3 Travel speed
- 4 Engine water temperature gauge
- 5 Hydraulic oil temperature gauge
- 6 Fuel gauge
- 7 ECO gauge
- 8 Function switches menu

Basic operation switches

- 1 Auto-decelerator (& auto idling)
- 2 Working mode selector
- 3 Traveling selector
- 4 Buzzer cancel
- 5 Wiper
- 6 Windshield washer

Mode Selection

The multi-function color monitor has Power mode and Economy mode (Four levels).

Working Mode	Application	Advantage
P (P0,P1)	Power mode	<ul style="list-style-type: none"> • Maximum production/power • Fast cycle time
E (E0,E1,E2,E3)	Economy mode	<ul style="list-style-type: none"> • Good cycle time • Good fuel economy

Additionally, it is possible to select “Heavy lift mode” or “Swing priority mode” for each Power mode and Economy mode.

Selection	Display on the monitor
Heavy lift mode	
Swing priority mode	

Equipment Management Monitoring System

Monitor function

Controller monitors engine oil level, coolant temperature, battery charge and air clogging, etc. If controller finds any abnormality, it is displayed on the LCD.



Maintenance function

Monitor informs replacement time for oil and filters when the replacement interval is reached.



Trouble data memory function

Monitor stores abnormalities for effective troubleshooting.

KOMTRAX

The Komatsu remote monitoring and management technology provides insightful data about your equipment and fleet in user-friendly format.

Energy Saving Operation Report

KOMTRAX delivers the energy-saving operation report based on the operating information such as fuel consumption, load summary and idling time, which helps you efficiently run a business.

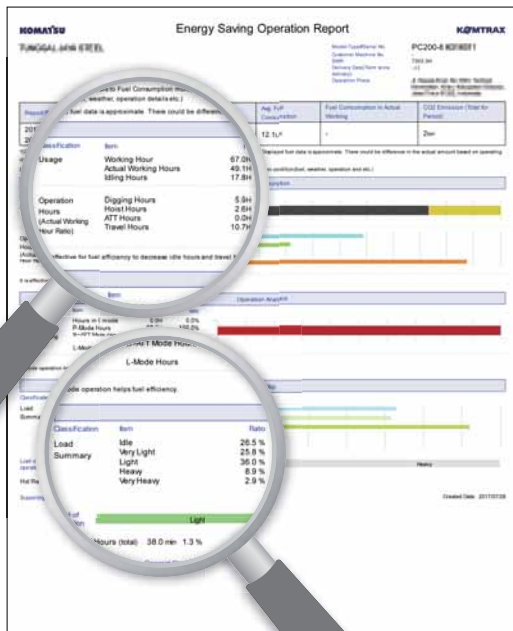

This report image is an example of hydraulic excavator

Equipment Management Support

Through the web application, a variety of search parameters are available to quickly find information about specific machines based on key factors. Moreover, KOMTRAX finds out machines with problems from your fleet and shows you through an optimal interface.

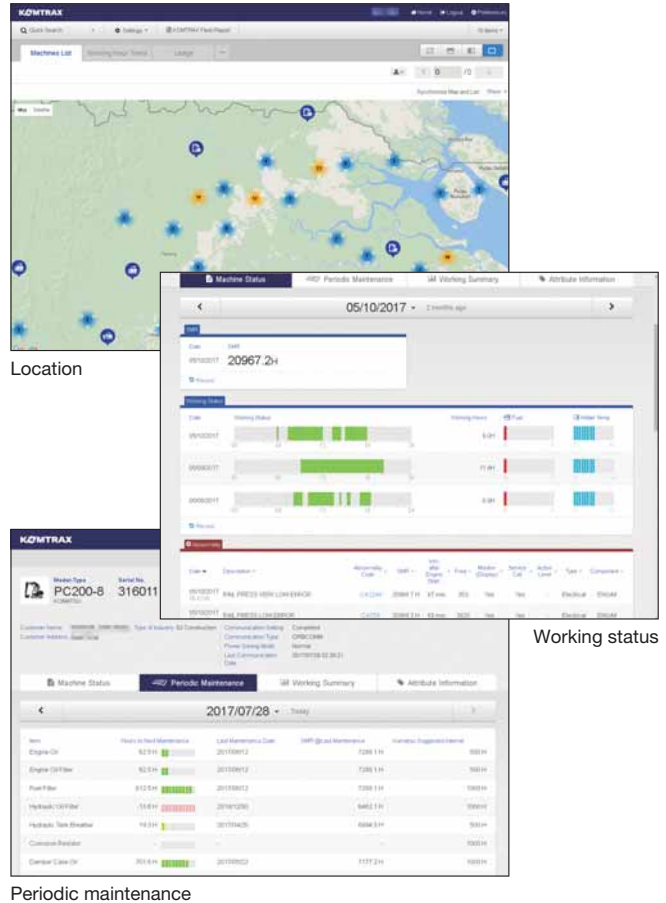

Location

Working status

Periodic maintenance

The report contents and data depend on the machine model.

Optimal Strategy for Efficient Work

The detailed information that KOMTRAX puts at your fingertips helps you manage your fleet conveniently on the web anytime, anywhere. It gives you the power to make better daily and long-term strategic decisions.



MAINTENANCE

Easy Checking and Maintenance of Engine

Engine check points are concentrated on one side of the engine to facilitate daily checks. Thermal guards are placed around high-temperature parts such as turbocharger.



One-touch Drain Cock

Easier, cleaner engine oil changes.

Easy Cleaning of Cooling Unit

Reverse-rotation function of the hydraulic driven fan simplifies cleaning out the cooling unit. In addition, this function contributes to reducing warming-up run time in low temperature and discharging hot air from the engine room to keep appropriate heat balance.

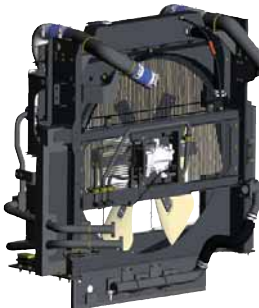

Long-life Oil, Filter

Uses high-performance filtering materials and long-life oil. Extends the oil and filter replacement interval.



Hydraulic oil filter

Engine oil & Engine oil filter	every 500 hours
Hydraulic oil	every 5000 hours
Hydraulic oil filter	every 1000 hours

Wide Catwalk

Easier, safer operator cab access and maintenance checks.



Steps Connected to the Machine Cab

Steps allows access from left hand catwalk to top of machine for engine check and maintenance.



Convenient Utility Space to the Machine Cab

Utility space provides great convenience to store tools, spare parts, etc.



Washable Cab Floormat

Cab floormat is easy to keep clean. The gently inclined surface has a flanged floormat and drainage holes to facilitate runoff.



Electric Pump, Grease Gun with Indicator (Optional)

Greasing is made easy with the electric pump and grease gun with indicator.

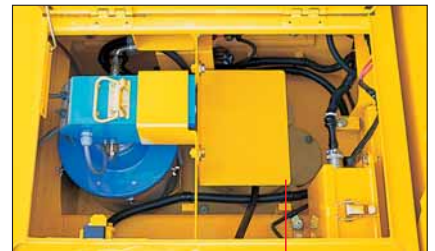

Grease can drum storage location



Grease gun
The grease gun can be reached from ground level.
Indicator

Divided Type Engine Cover

The divided engine cover allows easily access to inspection points around the engine.



Photo may include optional equipment.

KOMATSU BRAND BUCKET

KOMATSU Brand Bucket

Me Bucket Feature

- Low resistant excavation
- High productivity
- High durability
- High fuel efficiency



Conventional



Me bucket

Category and Feature

Category	Load / Wear / Soil (Application)	Image
Heavy Duty HD	<p>Load Machine power is high during majority of the work. Medium, but continuous shock load</p> <p>Wear Material is abrasive. Light scratch marks can be seen at the bucket.</p> <p>Soil Limestone, shot rock, compact mix of sand, gravel and clay</p>	
General Purpose GP	<p>Load Machine power is mostly medium, but occasionally high. Bucket movements are smooth with minor shock load. Bucket penetrates easily.</p> <p>Wear Material is lightly abrasive. Some sand may be medium abrasive.</p> <p>Soil Mostly loose sand, gravel and finely broken materials</p>	

Bucket Line-up

Bucket Type	Capacity (m ³)	Width*1 (mm)	Weight*2 (kg)	Tooth Quantity	Boom + Arm (m)				Tooth Type	Photo No
					STD			SE		
					8.2+3.6	8.2+4.6	8.2+5.6	7.1+2.9	KMAX	
Conventional	2.80	1725<1550>	2740	4	○	○	○	—	✓	①
	3.10	1875<1700>	2940	5	○	□	□	—	✓	②
	3.40	1870<1820>	3500	5	□	—	—	—	✓	③
	4.00	2100<2000>	3730	5	—	—	—	○	✓	④
	4.30	2250<2150>	3940	6	—	—	—	□	✓	⑤
	4.50	2330<2230>	4050	6	—	—	—	□	✓	⑥
Me Bucket*3	4.50	2100<2000>	4410	5	—	—	—	□	✓	⑦

*1 With side cutters or side shrouds, < > without side cutters or side shrouds *2 With side cutters *3 Special Features Request (SFR) required for Komatsu authorization by application.
 ○: Material density up to 1.8 t/m³ □: Material density up to 1.5 t/m³ ✓: Selectable

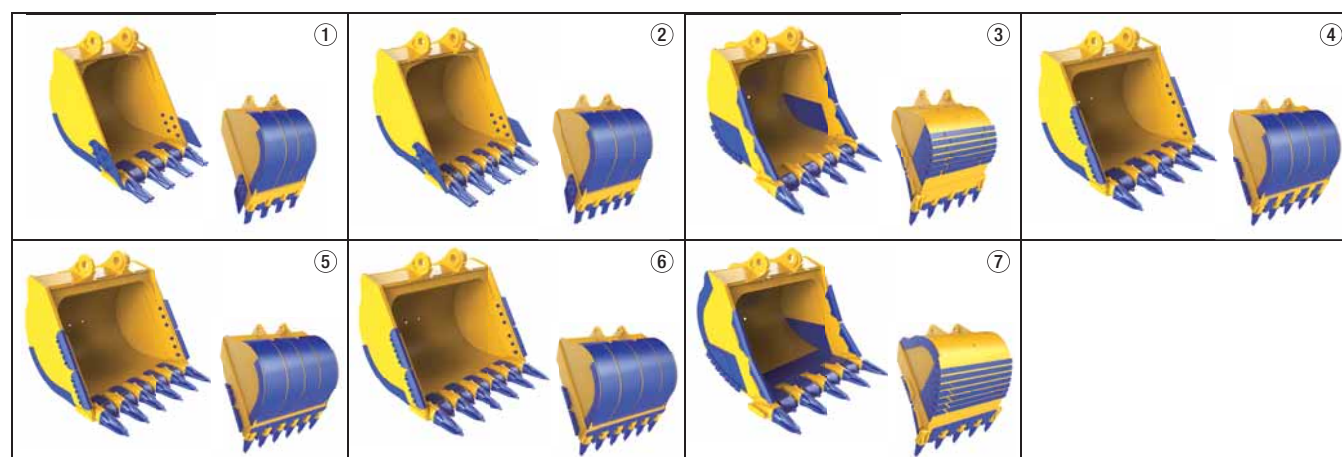

SE SPEC.

PC800/800LC-8R1 SE spec. is equipped with a large bucket. It increases the efficiency of loading a dump truck with large amounts of loose materials such as blasted rock.



Photos may include optional equipment.

OPTIONS

- Cab front full height guard level 2 (ISO 10262)



- OPG top guard level 2 (ISO 10262)

- Full length track roller guard



- Strengthened track frame undercover



- Flashing light



- Lower wiper



- Rain visor



- Sun visor



KOMATSU TOTAL SUPPORT



Komatsu Total Support

To keep your machine available and minimize operation cost when you need it, Komatsu Distributor is ready to provide a variety of supports before and after procuring the machine.

Fleet recommendation

Komatsu Distributor can study the customer's job site and provide the most optimum fleet recommendation with detailed information to meet all of your application needs when you are considering to buy new machines or replace the existing ones from Komatsu.



Product support

Komatsu Distributor gives the proactive support and secures the quality of the machinery that will be delivered.

Parts availability

Komatsu Distributor is available for emergency inquiry by the customers for genuine, quality guaranteed Komatsu parts.

Technical support

Komatsu product support service (Technical support) is designed to help customer. Komatsu Distributor offers a variety of effective services to show how much Komatsu is dedicated to the maintenance and support of Komatsu machine.

- Preventive Maintenance (PM) clinic
- Oil & Wear analysis program
- Undercarriage inspection service, etc.

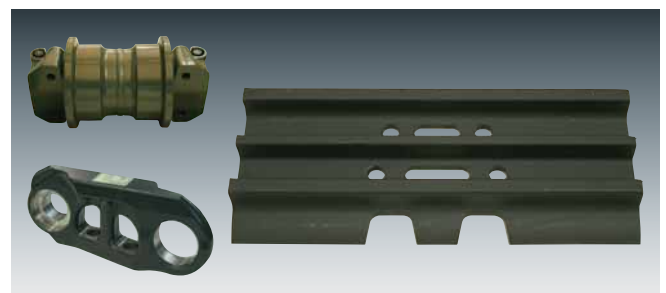

Repair & maintenance service

Komatsu Distributor offers quality repair and maintenance service to the customer, utilizing and promoting Komatsu developed programs.

Komatsu Reman (Remanufactured) components

Komatsu Reman products are the result of the implementation of the Komatsu global policy which establishes and agrees to reduce the owning, operating and total Life Cycle Costs (LCC) to Komatsu's customer through high quality, prompt delivery and competitively priced in own remanufactured products (QDC).



SPECIFICATIONS



ENGINE

Model Komatsu SAA6D140E-5
 Type 4-cycle, water-cooled, direct injection
 Aspiration Turbocharged, aftercooled
 Number of cylinders 6
 Bore 140 mm
 Stroke 165 mm
 Piston displacement 15.24 L
 Governor All-speed, electronic
 Horsepower:
 SAE J1995 Gross 370 kW 496 HP
 ISO 9249 / SAE J1349* Net 363 kW 487 HP
 Rated rpm 1800 rpm
 Fan drive type Hydraulic

* Net horsepower at the maximum speed of radiator cooling fan is 338 kW 454HP.
 U.S. EPA Tier 2 and EU Stage 2 emissions certified.



HYDRAULIC SYSTEM

Type Open-center load-sensing system
 Number of selectable working modes 2
 Main pump:
 Type Variable-capacity piston pumps
 Pumps for Boom, arm, bucket, swing, and travel circuits
 Maximum flow 2 x 494 L/min
 Fan drive pump Variable capacity piston type
 Hydraulic motors:
 Travel 2 x axial piston motor with parking brake
 Swing 2 x axial piston motor with swing holding brake
 Relief valve setting:
 Implement circuits 31.4 MPa 320 kg/cm²
 Travel circuit 34.3 MPa 350 kg/cm²
 Swing circuit 28.4 MPa 290 kg/cm²
 Heavy lift circuit (Backhoe only) 34.3 MPa 350 kg/cm²
 Pilot circuit 2.9 MPa 30 kg/cm²
 Hydraulic cylinders:
 (Number of cylinders—bore x stroke x rod diameter)
 Boom 2 – 200 mm x 1950 mm x 140 mm
 Arm
 Std 1 – 200 mm x 2250 mm x 140 mm
 SE 2 – 185 mm x 1610 mm x 120 mm
 Bucket
 Std 1 – 185 mm x 1610 mm x 130 mm
 SE 1 – 225 mm x 1420 mm x 160 mm



DRIVES AND BRAKES

Steering control Two levers with pedals
 Drive method Fully hydrostatic
 Travel motor Axial piston motor, in-shoe design
 Reduction system Planetary gear triple reduction
 Maximum drawbar pull 559 kN 57000 kg
 Gradeability 70%
 Maximum travel speed
 Low 2.8 km/h
 High 4.2 km/h
 Service brake Hydraulic lock
 Parking brake Oil disc brake



SWING SYSTEM

Driven method Hydraulic motors
 Swing reduction Planetary gear
 Swing circle lubrication Grease-bathed
 Swing lock Oil disc brake
 Swing speed 6.8 rpm



UNDERCARRIAGE

Center frame H-leg frame
 Track frame Box-section
 Seal of track Sealed
 Track adjuster Hydraulic
 No. of shoes (Each side) 47 (PC800-8R1), 51 (PC800LC-8R1)
 No. of carrier rollers (Each side) 3
 No. of track rollers (Each side) 8 (PC800-8R1), 9 (PC800LC-8R1)



COOLANT AND LUBRICANT CAPACITY (REFILLING)

Fuel tank 980 L
 Radiator 100 L
 Engine 53 L
 Final drive, each side 20 L
 Swing drive 24.5 x 2 L
 Hydraulic tank 470 L



BACKHOE OPERATING WEIGHT (APPROXIMATE)

PC800-8R1: Operating weight, including 8200 mm boom, 3600 mm arm, ISO 7451 heaped 3.10 m³ backhoe bucket, operator, lubricant, coolant, full fuel tank, and the standard equipment

PC800-8R1 SE spec.: Operating weight, including 7100 mm boom, 2945 mm arm, ISO 7451 heaped 4.00 m³ backhoe bucket, operator, lubricant, coolant, full fuel tank, and the standard equipment

Shoes	PC800-8R1		PC800-8R1 SE Spec.	
	Operating Weight	Ground Pressure	Operating Weight	Ground Pressure
610 mm	74500 kg	122 kPa 1.24 kg/cm ²	75500 kg	123 kPa 1.25 kg/cm ²
710 mm	75300 kg	106 kPa 1.08 kg/cm ²	76300 kg	107 kPa 1.09 kg/cm ²
810 mm	75830 kg	93 kPa 0.95 kg/cm ²	76830 kg	94 kPa 0.96 kg/cm ²
910 mm	76470 kg	83 kPa 0.85 kg/cm ²	77470 kg	84 kPa 0.86 kg/cm ²
1010 mm	77110 kg	76 kPa 0.77 kg/cm ²	78110 kg	76 kPa 0.78 kg/cm ²

Shoe	PC800LC-8R1		PC800LC-8R1 SE Spec.	
	Operating Weight	Ground Pressure	Operating Weight	Ground Pressure
810 mm	77500 kg	86 kPa 0.88 kg/cm ²	78500 kg	87 kPa 0.89 kg/cm ²
1010 mm	78900 kg	74 kPa 0.72 kg/cm ²	79900 kg	72 kPa 0.73 kg/cm ²



BACKHOE DIMENSIONS

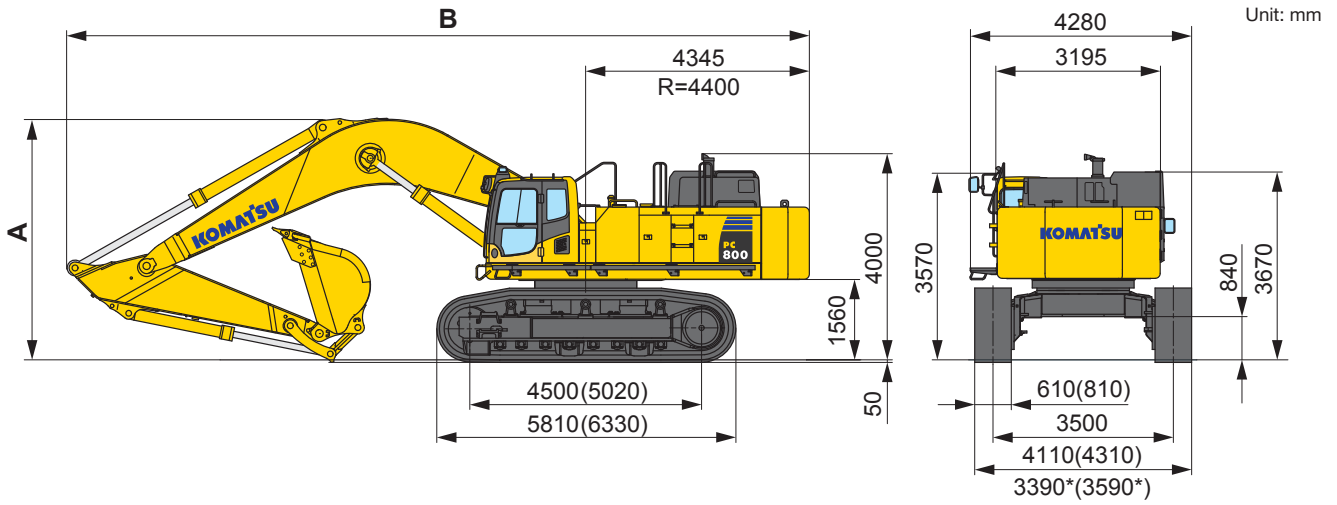

Model	PC800/800LC-8R1			PC800/800LC-8R1 SE Spec.
Boom Length	8200 mm			7100 mm
Arm Length	3600 mm	4600 mm	5600 mm	2945 mm
A Overall height	4690 mm	5630 mm	6260 mm	4615 mm
B Overall length	14405 mm	14435 mm	14115 mm	13130 mm

* When retracted
(): PC800LC-8R1



BACKHOE WORKING RANGE

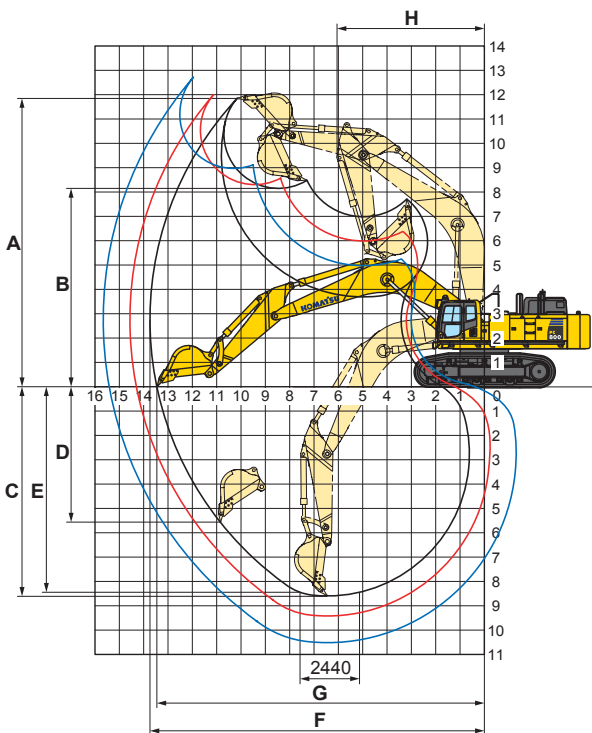

Model	PC800/800LC-8R1			PC800/800LC-8R1 SE Spec.	
Boom Length	8200 mm			7100 mm	
Arm Length	3600 mm	4600 mm	5600 mm	2945 mm	
A Max. digging height	11840 mm	12000 mm	12690 mm	11330 mm	
B Max. dumping height	8145 mm	8295 mm	8890 mm	7525 mm	
C Max. digging depth	8600 mm	9590 mm	10595 mm	7130 mm	
D Max. vertical wall digging depth	5575 mm	6575 mm	7920 mm	4080 mm	
E Max. digging depth of cut for 2440 mm level	8445 mm	9455 mm	10500 mm	6980 mm	
F Max. digging reach	13740 mm	14575 mm	15635 mm	12265 mm	
G Max. digging reach at ground level	13460 mm	14310 mm	15385 mm	11945 mm	
H Min. swing radius	6060 mm	6085 mm	6145 mm	5645 mm	
SAE 1179 Rating	Bucket digging force at power max.	324 kN 33000 kg	324 kN 33000 kg	324 kN 33000 kg	428 kN 43600 kg
	Arm crowd force at power max.	260 kN 26500 kg	233 kN 23800 kg	198 kN 20200 kg	363 kN 37000 kg
ISO 6015 Rating	Bucket digging force at power max.	364 kN 37200 kg	364 kN 37200 kg	364 kN 37200 kg	471 kN 48000 kg
	Arm crowd force at power max.	273 kN 27900 kg	242 kN 24700 kg	205 kN 20900 kg	373 kN 38100 kg



LOADING SHOVEL DIMENSIONS

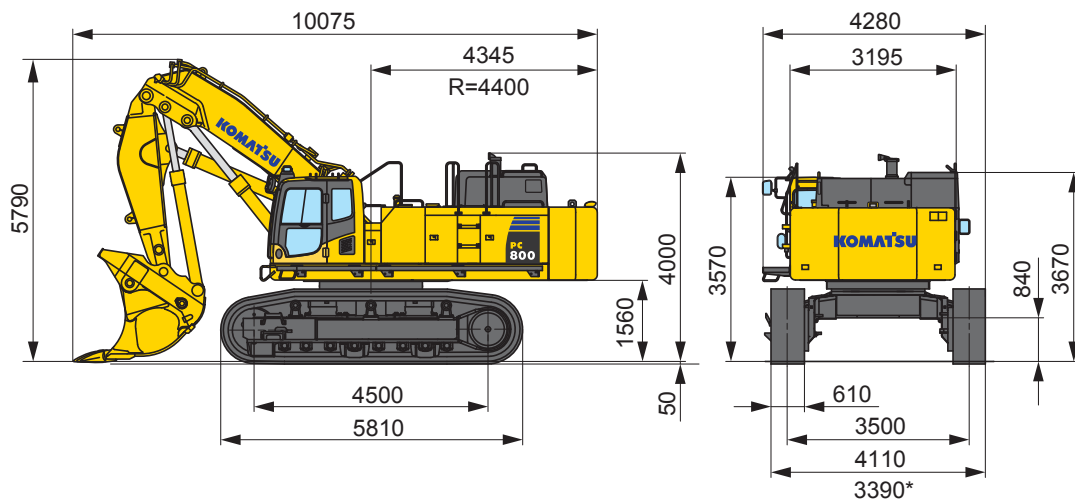

Unit: mm

* When retracted
Loading shovel is not available for PC800LC-8R1



LOADING SHOVEL WORKING RANGE AND BUCKET SELECTION

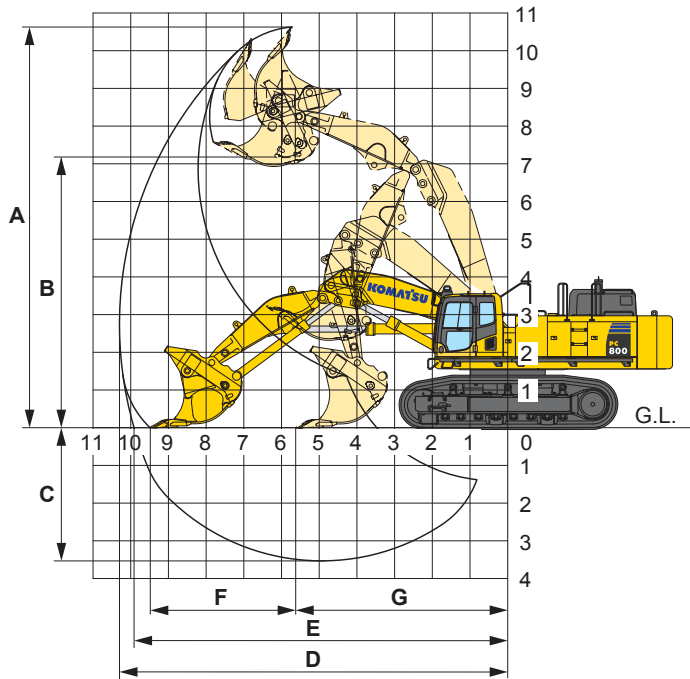

Working Range

Model	PC800-8R1	
Type of Bucket	Bottom Dump	
Capacity-heaped	4.50 m ³	5.10 m ³
A	Max. cutting height	
B	Max. dumping height	
C	Max. digging depth	
D	Max. digging reach	
E	Max. digging reach at ground level	
F	Level crowding distance	
G	Min. crowd distance	
H	Min. swing radius	
Bucket digging force	477 kN	48600 kg
Arm crowd force	404 kN	41200 kg

Bucket Selection

Model	PC800-8R1	
Type of Bucket	Bottom Dump	
Capacity-heaped	4.50 m ³	5.10 m ³
Width	2320 mm	2620 mm
Weight	6995 kg	7665 kg
No. of bucket teeth	6	6
Recommended uses	General-purpose digging and loading	Light-duty excavation and loading



LOADING SHOVEL OPERATING WEIGHT

Operating weight, including 4600 mm boom, 3400 mm arm, ISO 7451 heaped 4.50 m³ bucket, operator, lubricants, coolant, full fuel tank and standard equipment.

Shoes	Operating Weight	Ground Pressure
610 mm	77300 kg	126 kPa 1.28 kg/cm ²
710 mm	78100 kg	110 kPa 1.12 kg/cm ²



LIFTING CAPACITY

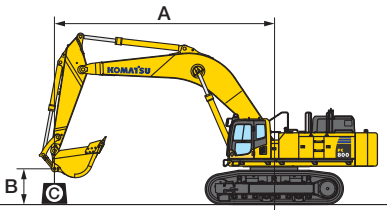

PC800-8R1

- A: Reach from swing center
- B: Bucket hook height
- C: Lifting capacity
- Cf: Rating over front
- Cs: Rating over side
- ⊗: Rating at maximum reach

HEAVY LIFT "OFF"

PC800-8R1		Boom: 8200 mm		Arm: 3600 mm		Bucket: 3.10 m ³ ISO 7451 heaped		Shoe: 610 mm double grouser		Counterweight: 9.8 t			
B	A	⊗ MAX		9.0 m		7.5 m		6.0 m		4.5 m		3.0 m	
		Cf	Cs	Cf	Cs	Cf	Cs	Cf	Cs	Cf	Cs	Cf	Cs
6.0 m		*7750 kg	*7750 kg	*12250 kg	*12250 kg	*14050 kg	*14050 kg						
3.0 m		*9050 kg	7150 kg	*14600 kg	12100 kg	*17950 kg	16300 kg	*23900 kg	23000 kg				
0 m		9350 kg	7050 kg	14200 kg	10850 kg	19000 kg	14450 kg	*21700 kg	20400 kg	*13550 kg	*13550 kg		
-3.0 m		11050 kg	8350 kg	13800 kg	10450 kg	18500 kg	13950 kg	*22450 kg	20100 kg	*20300 kg	*20300 kg	*19100 kg	*19100 kg
-6.0 m		*13800 kg	13600 kg			*14900 kg	14750 kg	*19100 kg	*19100 kg	*22500 kg	*22500 kg		

HEAVY LIFT "ON"

PC800-8R1		Boom: 8200 mm		Arm: 3600 mm		Bucket: 3.10 m ³ ISO 7451 heaped		Shoe: 610 mm double grouser		Counterweight: 9.8 t			
B	A	⊗ MAX		9.0 m		7.5 m		6.0 m		4.5 m		3.0 m	
		Cf	Cs	Cf	Cs	Cf	Cs	Cf	Cs	Cf	Cs	Cf	Cs
6.0 m		*8800 kg	8400 kg	*14000 kg	13700 kg	*16000 kg	*16000 kg						
3.0 m		9350 kg	7150 kg	15550 kg	12100 kg	*20500 kg	16300 kg	*26900 kg	23000 kg				
0 m		9350 kg	7050 kg	14200 kg	10850 kg	19000 kg	14450 kg	*21700 kg	20400 kg	*15100 kg	*15100 kg		
-3.0 m		11050 kg	8350 kg	13800 kg	10450 kg	18500 kg	13950 kg	*22450 kg	20100 kg	*20300 kg	*20300 kg	*21200 kg	*21200 kg
-6.0 m		*16050 kg	13600 kg			*17250 kg	14750 kg	*22050 kg	21250 kg	*22500 kg	*22500 kg		

* Load is limited by hydraulic capacity rather than tipping. Ratings are based on SAE J1097. Rated loads do not exceed 87% of hydraulic lift capacity or 75% of tipping load.

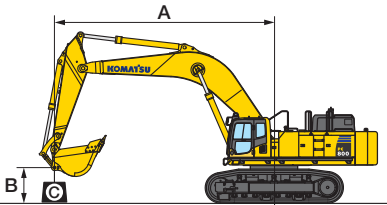

PC800-8R1

- A: Reach from swing center
- B: Bucket hook height
- C: Lifting capacity
- Cf: Rating over front
- Cs: Rating over side
- ⊗: Rating at maximum reach

HEAVY LIFT "OFF"

PC800-8R1		Boom: 8200 mm		Arm: 4600 mm		Bucket: 2.80 m ³ ISO 7451 heaped		Shoe: 610 mm double grouser		Counterweight: 9.8 t					
B	A	⊗ MAX		12.0 m		9.0 m		7.5 m		6.0 m		4.5 m		3.0 m	
		Cf	Cs	Cf	Cs	Cf	Cs	Cf	Cs	Cf	Cs	Cf	Cs	Cf	Cs
6.0 m		*6400 kg	*6400 kg	*7900 kg	7800 kg	*10750 kg	*10750 kg								
3.0 m		*7350 kg	6150 kg	9400 kg	7150 kg	*13,400 kg	12450 kg	*16350 kg	*16350 kg	*21400 kg	*21400 kg				
0 m		8050 kg	6000 kg	8750 kg	6550 kg	14350 kg	10950 kg	19300 kg	14700 kg	*25950 kg	20800 kg	*14600 kg	*14600 kg		
-3.0 m		9200 kg	6850 kg			13600 kg	10250 kg	18300 kg	13750 kg	*26050 kg	19800 kg	*23500 kg	*23500 kg	*15950 kg	*15,950 kg
-6.0 m		*12650 kg	10050 kg			*13300 kg	10500 kg	*17100 kg	14050 kg	*21850 kg	20400 kg	*28600 kg	*28600 kg	*27150 kg	*27150 kg

HEAVY LIFT "ON"

PC800-8R1		Boom: 8200 mm		Arm: 4600 mm		Bucket: 2.80 m ³ ISO 7451 heaped		Shoe: 610 mm double grouser		Counterweight: 9.8 t					
B	A	⊗ MAX		12.0 m		9.0 m		7.5 m		6.0 m		4.5 m		3.0 m	
		Cf	Cs	Cf	Cs	Cf	Cs	Cf	Cs	Cf	Cs	Cf	Cs	Cf	Cs
6.0 m		*7350 kg	7200 kg	*9000 kg	7800 kg	*12350 kg	*12350 kg								
3.0 m		8150 kg	6150 kg	9400 kg	7150 kg	*15400 kg	12450 kg	*18700 kg	17000 kg	*24350 kg	*24350 kg				
0 m		8050 kg	6000 kg	8750 kg	6550 kg	14350 kg	10950 kg	19300 kg	14700 kg	27800 kg	20800 kg	*16300 kg	*16300 kg		
-3.0 m		9200 kg	6850 kg			13600 kg	10250 kg	18300 kg	13750 kg	26750 kg	19800 kg	*26000 kg	*26000 kg	*17750 kg	*17750 kg
-6.0 m		13300 kg	10050 kg			13900 kg	10500 kg	18650 kg	14050 kg	*25150 kg	20400 kg	*30800 kg	*30800 kg	*27150 kg	*27150 kg

* Load is limited by hydraulic capacity rather than tipping. Ratings are based on SAE J1097. Rated loads do not exceed 87% of hydraulic lift capacity or 75% of tipping load.



LIFTING CAPACITY

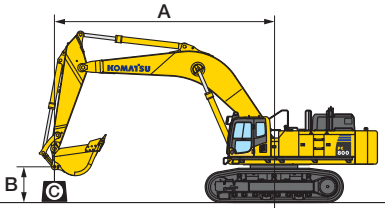

PC800-8R1

- A: Reach from swing center
- B: Bucket hook height
- C: Lifting capacity
- Cf: Rating over front
- Cs: Rating over side
- ⊗: Rating at maximum reach

HEAVY LIFT "OFF"

PC800-8R1		Boom: 8200 mm		Arm: 5600 mm		Bucket: 2.80 m ³ ISO 7451 heaped		Shoe: 610 mm double grouser		Counterweight: 9.8 t					
B	A	⊗ MAX		12.0 m		9.0 m		7.5 m		6.0 m		4.5 m		3.0 m	
		Cf	Cs	Cf	Cs	Cf	Cs	Cf	Cs	Cf	Cs	Cf	Cs	Cf	Cs
6.0 m		*4050 kg	*4050 kg	*7050 kg	*7050 kg										
3.0 m		*4550 kg	*4550 kg	*9100 kg	7100 kg	*11800 kg	*11800 kg	*14250 kg	*14250 kg	*18400 kg	*18400 kg				
0 m		*5650 kg	4750 kg	8500 kg	6300 kg	14250 kg	10850 kg	*18050 kg	14700 kg	*24200 kg	21000 kg	*15150 kg	*15150 kg		
-3.0 m		7400 kg	5350 kg	8050 kg	5850 kg	13150 kg	9800 kg	17850 kg	13300 kg	*25700 kg	19200 kg	*20100 kg	*20100 kg	*12850 kg	*12850 kg
-6.0 m		9950 kg	7350 kg			13100 kg	9750 kg	17750 kg	13200 kg	*23100 kg	19300 kg	*24300 kg	*24300 kg	*22250 kg	*22250 kg

HEAVY LIFT "ON"

PC800-8R1		Boom: 8200 mm		Arm: 5600 mm		Bucket: 2.80 m ³ ISO 7451 heaped		Shoe: 610 mm double grouser		Counterweight: 9.8 t					
B	A	⊗ MAX		12.0 m		9.0 m		7.5 m		6.0 m		4.5 m		3.0 m	
		Cf	Cs	Cf	Cs	Cf	Cs	Cf	Cs	Cf	Cs	Cf	Cs	Cf	Cs
6.0 m		*4750 kg	*4750 kg	*8050 kg	7900 kg										
3.0 m		*5350 kg	4950 kg	9350 kg	7100 kg	*13650 kg	12650 kg	*16400 kg	*16400 kg	*20950 kg	*20950 kg				
0 m		*6550 kg	4750 kg	8500 kg	6300 kg	14250 kg	10850 kg	19350 kg	14700 kg	*27650 kg	21000 kg	*16900 kg	*16900 kg		
-3.0 m		7400 kg	5350 kg	8050 kg	5850 kg	13150 kg	9800 kg	17850 kg	13300 kg	26100 kg	19200 kg	*22300 kg	*22300 kg	*14400 kg	*14400 kg
-6.0 m		9950 kg	7350 kg			13100 kg	9750 kg	17750 kg	13200 kg	26200 kg	19300 kg	*24300 kg	*24300 kg	*22250 kg	*22250 kg

* Load is limited by hydraulic capacity rather than tipping. Ratings are based on SAE J1097. Rated loads do not exceed 87% of hydraulic lift capacity or 75% of tipping load.

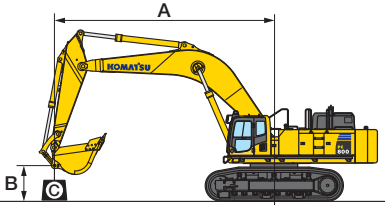

PC800-8R1 SE Spec.

- A: Reach from swing center
- B: Bucket hook height
- C: Lifting capacity
- Cf: Rating over front
- Cs: Rating over side
- ⊗: Rating at maximum reach

HEAVY LIFT "OFF"

PC800-8R1 SE Spec.		Boom: 7100 mm		Arm: 2900 mm		Bucket: 4.00 m ³ ISO 7451 heaped		Shoe: 610 mm double grouser		Counterweight: 9.8 t			
B	A	⊗ MAX		9.0 m		7.5 m		6.0 m		4.5 m		3.0 m	
		Cf	Cs	Cf	Cs	Cf	Cs	Cf	Cs	Cf	Cs	Cf	Cs
6.0 m		*12300 kg	10100 kg	*12800 kg	12450 kg	*14400 kg	*14400 kg						
3.0 m		11050 kg	8300 kg	14650 kg	11200 kg	*17850 kg	15600 kg	*23450 kg	22750 kg				
0 m		11300 kg	8400 kg	13600 kg	10200 kg	18550 kg	13950 kg	*26250 kg	20150 kg	*28600 kg	*28600 kg		
-3.0 m		*14550 kg	11100 kg			*18000 kg	13800 kg	*23550 kg	20150 kg	*31050 kg	*31050 kg	*31800 kg	*31800 kg

HEAVY LIFT "ON"

PC800-8R1 SE Spec.		Boom: 7100 mm		Arm: 2900 mm		Bucket: 4.00 m ³ ISO 7451 heaped		Shoe: 610 mm double grouser		Counterweight: 9.8 t			
B	A	⊗ MAX		9.0 m		7.5 m		6.0 m		4.5 m		3.0 m	
		Cf	Cs	Cf	Cs	Cf	Cs	Cf	Cs	Cf	Cs	Cf	Cs
6.0 m		13150 kg	10100 kg	*14800 kg	12450 kg	*16500 kg	*16500 kg						
3.0 m		11050 kg	8300 kg	14650 kg	11200 kg	20,350 kg	15600 kg	*26750 kg	22750 kg				
0 m		11300 kg	8400 kg	13600 kg	10200 kg	18550 kg	13950 kg	27200 kg	20150 kg	*31350 kg	*31350 kg		
-3.0 m		14800 kg	11100 kg			18400 kg	13800 kg	*27050 kg	20150 kg	*32200 kg	*32200 kg	*31800 kg	*31800 kg

* Load is limited by hydraulic capacity rather than tipping. Ratings are based on SAE J1097. Rated loads do not exceed 87% of hydraulic lift capacity or 75% of tipping load.



LIFTING CAPACITY

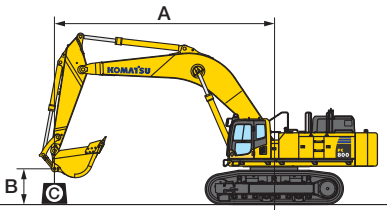

PC800LC-8R1

- A: Reach from swing center
- B: Bucket hook height
- C: Lifting capacity
- Cf: Rating over front
- Cs: Rating over side
- ⊗: Rating at maximum reach

HEAVY LIFT "OFF"

PC800LC-8R1													
Boom: 8200 mm			Arm: 3600 mm			Bucket: 3.10 m ³ ISO 7451 heaped			Shoe: 810 mm double grouser		Counterweight: 9.8 t		
B	A	⊗ MAX		9.0 m		7.5 m		6.0 m		4.5 m		3.0 m	
		Cf	Cs	Cf	Cs	Cf	Cs	Cf	Cs	Cf	Cs	Cf	Cs
6.0 m		*7750 kg	*7750 kg	*12250 kg	*12250 kg	*14050 kg	*14050 kg						
3.0 m		*9050 kg	7550 kg	*14600 kg	12700 kg	*17950 kg	17050 kg	*23900 kg	*23900 kg				
0 m		11850 kg	7450 kg	*16250 kg	11450 kg	*20300 kg	15200 kg	*21700 kg	21400 kg	*13550 kg	*13550 kg		
-3.0 m		*12950 kg	8850 kg	*15850 kg	11050 kg	*19800 kg	14700 kg	*22450 kg	21150 kg	*20300 kg	*20300 kg	*19100 kg	*19100 kg
-6.0 m		*13800 kg	*13800 kg			*14900 kg	*14900 kg	*19100 kg	*19100 kg	*22500 kg	*22500 kg		

HEAVY LIFT "ON"

PC800LC-8R1													
Boom: 8200 mm			Arm: 3600 mm			Bucket: 3.10 m ³ ISO 7451 heaped			Shoe: 810 mm double grouser		Counterweight: 9.8 t		
B	A	⊗ MAX		9.0 m		7.5 m		6.0 m		4.5 m		3.0 m	
		Cf	Cs	Cf	Cs	Cf	Cs	Cf	Cs	Cf	Cs	Cf	Cs
6.0 m		*8800 kg	*8800 kg	*14000 kg	*14000 kg	*16000 kg	*16000 kg						
3.0 m		*10200 kg	7550 kg	*16750 kg	12700 kg	*20500 kg	17050 kg	*26900 kg	24050 kg				
0 m		11850 kg	7450 kg	17900 kg	11450 kg	*23250 kg	15200 kg	*21700 kg	21400 kg	*15100 kg	*15100 kg		
-3.0 m		13950 kg	8850 kg	17450 kg	11050 kg	*22700 kg	14700 kg	*22450 kg	21150 kg	*20300 kg	*20300 kg	*21200 kg	*21200 kg
-6.0 m		*16050 kg	14300 kg			*17250 kg	15500 kg	*22050 kg	*22050 kg	*22500 kg	*22500 kg		

* Load is limited by hydraulic capacity rather than tipping. Ratings are based on SAE J1097. Rated loads do not exceed 87% of hydraulic lift capacity or 75% of tipping load.

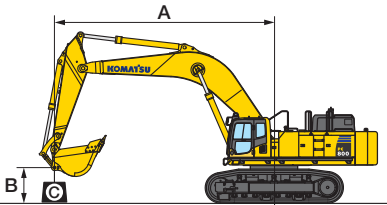

PC800LC-8R1

- A: Reach from swing center
- B: Bucket hook height
- C: Lifting capacity
- Cf: Rating over front
- Cs: Rating over side
- ⊗: Rating at maximum reach

HEAVY LIFT "OFF"

PC800LC-8R1													
Boom: 8200 mm			Arm: 4600 mm			Bucket: 2.80 m ³ ISO 7451 heaped			Shoe: 810 mm double grouser		Counterweight: 9.8 t		
B	A	⊗ MAX		9.0 m		7.5 m		6.0 m		4.5 m		3.0 m	
		Cf	Cs	Cf	Cs	Cf	Cs	Cf	Cs	Cf	Cs	Cf	Cs
6.0 m		*6400 kg	*6400 kg	*10750 kg	*10750 kg	*14050 kg	*14050 kg						
3.0 m		*7350 kg	6500 kg	*13400 kg	13050 kg	*16350 kg	*16350 kg	*21450 kg	*21450 kg				
0 m		*9300 kg	6400 kg	*15550 kg	11550 kg	*19500 kg	15400 kg	*25950 kg	21800 kg	*14650 kg	*14650 kg		
-3.0 m		*11500 kg	7300 kg	*16000 kg	10800 kg	*20050 kg	14500 kg	*26050 kg	20850 kg	*23500 kg	*23500 kg	*15950 kg	*15950 kg
-6.0 m		*12650 kg	10650 kg	*13300 kg	11100 kg	*17050 kg	14800 kg	*21850 kg	21450 kg	*28600 kg	*28600 kg	*27150 kg	*27150 kg

HEAVY LIFT "ON"

PC800LC-8R1													
Boom: 8200 mm			Arm: 4600 mm			Bucket: 2.80 m ³ ISO 7451 heaped			Shoe: 810 mm double grouser		Counterweight: 9.8 t		
B	A	⊗ MAX		9.0 m		7.5 m		6.0 m		4.5 m		3.0 m	
		Cf	Cs	Cf	Cs	Cf	Cs	Cf	Cs	Cf	Cs	Cf	Cs
6.0 m		*7350 kg	*7350 kg	*12350 kg	*12350 kg	*16000 kg	*16000 kg						
3.0 m		*8350 kg	6500 kg	*15400 kg	13050 kg	*18700 kg	*17750 kg	*24350 kg	*24350 kg				
0 m		10300 kg	6400 kg	*17900 kg	11550 kg	*22350 kg	15400 kg	*29600 kg	21800 kg	*16350 kg	*16350 kg		
-3.0 m		11750 kg	7300 kg	17250 kg	10800 kg	*23050 kg	14500 kg	*29750 kg	20850 kg	*26050 kg	*26050 kg	*17800 kg	*17800 kg
-6.0 m		*14750 kg	10650 kg	*15450 kg	11100 kg	*19750 kg	14800 kg	*25100 kg	21450 kg	*30800 kg	*30800 kg	*27150 kg	*27150 kg

* Load is limited by hydraulic capacity rather than tipping. Ratings are based on SAE J1097. Rated loads do not exceed 87% of hydraulic lift capacity or 75% of tipping load.



LIFTING CAPACITY

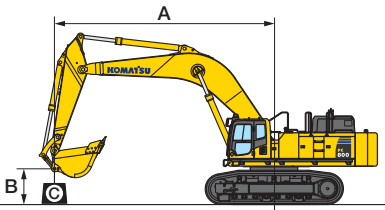

PC800LC-8R1

- A: Reach from swing center
- B: Bucket hook height
- C: Lifting capacity
- Cf: Rating over front
- Cs: Rating over side
- ⊗: Rating at maximum reach

HEAVY LIFT "OFF"

PC800LC-8R1													
		Boom: 8200 mm		Arm: 5600 mm		Bucket: 2.80 m ³ ISO 7451 heaped		Shoe: 810 mm double grouser		Counterweight: 9.8 t			
B	A	⊗ MAX		9.0 m		7.5 m		6.0 m		4.5 m		3.0 m	
		Cf	Cs	Cf	Cs	Cf	Cs	Cf	Cs	Cf	Cs	Cf	Cs
6.0 m		*4050 kg	*4050 kg	*12250 kg	*12250 kg	*14050 kg	*14050 kg						
3.0 m		*4550 kg	*4550 kg	*11850 kg	*11850 kg	*14300 kg	*14300 kg	*18400 kg	*18400 kg				
0 m		*5650 kg	5150 kg	*14350 kg	11450 kg	*18050 kg	15450 kg	*24200 kg	22000 kg	*15150 kg	*15150 kg		
-3.0 m		*7950 kg	5750 kg	*15500 kg	10400 kg	*19500 kg	14000 kg	*25750 kg	20200 kg	*20100 kg	*20100 kg	*12900 kg	*12900 kg
-6.0 m		*10700 kg	7850 kg	*14100 kg	10300 kg	*17900 kg	13950 kg	*23100 kg	20350 kg	*24300 kg	*24300 kg	*22250 kg	*22250 kg

HEAVY LIFT "ON"

PC800LC-8R1													
		Boom: 8200 mm		Arm: 5600 mm		Bucket: 2.80 m ³ ISO 7451 heaped		Shoe: 810 mm double grouser		Counterweight: 9.8 t			
B	A	⊗ MAX		9.0 m		7.5 m		6.0 m		4.5 m		3.0 m	
		Cf	Cs	Cf	Cs	Cf	Cs	Cf	Cs	Cf	Cs	Cf	Cs
6.0 m		*4750 kg	*4750 kg	*14000 kg	13700 kg	*16000 kg	*16000 kg						
3.0 m		*5350 kg	5300 kg	*13700 kg	13250 kg	*16400 kg	*16400 kg	*21000 kg	*21000 kg				
0 m		*6550 kg	5150 kg	*16600 kg	11450 kg	*20800 kg	15450 kg	*27650 kg	22000 kg	*16900 kg	*16900 kg		
-3.0 m		*9050 kg	5750 kg	16850 kg	10400 kg	*22500 kg	14000 kg	*26650 kg	20200 kg	*22350 kg	*22350 kg	*14450 kg	*14450 kg
-6.0 m		*12550 kg	7850 kg	*16450 kg	10300 kg	*20700 kg	13950 kg	*26600 kg	20350 kg	*24300 kg	*24300 kg	*22250 kg	*22250 kg

* Load is limited by hydraulic capacity rather than tipping. Ratings are based on SAE J1097. Rated loads do not exceed 87% of hydraulic lift capacity or 75% of tipping load.

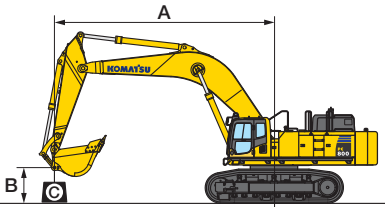

PC800LC-8R1 SE Spec.

- A: Reach from swing center
- B: Bucket hook height
- C: Lifting capacity
- Cf: Rating over front
- Cs: Rating over side
- ⊗: Rating at maximum reach

HEAVY LIFT "OFF"

PC800LC-8R1 SE Spec.													
		Boom: 7100 mm		Arm: 2900 mm		Bucket: 4.00 m ³ ISO 7451 heaped		Shoe: 810 mm double grouser		Counterweight: 9.8 t			
B	A	⊗ MAX		9.0 m		7.5 m		6.0 m		4.5 m		3.0 m	
		Cf	Cs	Cf	Cs	Cf	Cs	Cf	Cs	Cf	Cs	Cf	Cs
6.0 m		*12300 kg	10650 kg	*12800 kg	*12800 kg	*14400 kg	*14400 kg						
3.0 m		*12750 kg	8800 kg	*14650 kg	11800 kg	*17850 kg	16350 kg	*23450 kg	*23450 kg				
0 m		*13650 kg	8950 kg	*15800 kg	10800 kg	*19900 kg	14700 kg	*26250 kg	21150 kg	*28600 kg	*28600 kg		
-3.0 m		*14550 kg	11700 kg			*18000 kg	14550 kg	*23550 kg	21150 kg	*31050 kg	*31050 kg	*31800 kg	*31800 kg

HEAVY LIFT "ON"

PC800LC-8R1 SE Spec.													
		Boom: 7100 mm		Arm: 2900 mm		Bucket: 4.00 m ³ ISO 7451 heaped		Shoe: 810 mm double grouser		Counterweight: 9.8 t			
B	A	⊗ MAX		9.0 m		7.5 m		6.0 m		4.5 m		3.0 m	
		Cf	Cs	Cf	Cs	Cf	Cs	Cf	Cs	Cf	Cs	Cf	Cs
6.0 m		*14250 kg	10650 kg	*14800 kg	13000 kg	*16500 kg	*16500 kg						
3.0 m		14050 kg	8800 kg	*16950 kg	11800 kg	*20500 kg	16350 kg	*26750 kg	23750 kg				
0 m		14400 kg	8950 kg	17300 kg	10800 kg	*22850 kg	14700 kg	*30000 kg	21150 kg	*31350 kg	*31350 kg		
-3.0 m		*16900 kg	11700 kg			*20800 kg	14550 kg	*27050 kg	21150 kg	*32200 kg	*32200 kg	*31800 kg	*31800 kg

* Load is limited by hydraulic capacity rather than tipping. Ratings are based on SAE J1097. Rated loads do not exceed 87% of hydraulic lift capacity or 75% of tipping load.



TRANSPORTATION GUIDE

Transportation specifications (Length x height x width)

Backhoe () : PC800LC-8R1

Specs shown include the following equipment:

STD spec. : Boom 8200 mm, Arm 3600 mm, Bucket 3.10 m³, Shoes 610 mm (810 mm) double grouser

SE spec. : Boom 7100 mm, Arm 2945 mm, Bucket 4.00 m³, Shoes 610 mm (810 mm) double grouser

Loading Shovel

Specs shown include the following equipment:

Boom 4600 mm, Arm 3400 mm,

Bucket 4.50 m³, Shoes 610 mm double grouser

3 Kits Transportation

Work equipment assembly

Weight : STD spec. : 17.1 t
SE spec. : 18.1 t

Boom

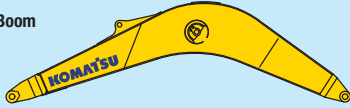

STD spec. : 7.9 t : 8530 x 2615 x 1500 mm
SE spec. : 7.3 t : 7430 x 2480 x 1500 mm

Arm

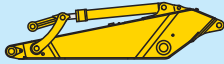

STD spec. : 4.0 t : 5115 x 1365 x 710 mm
SE spec. : 4.9 t : 4075 x 1690 x 715 mm

Bucket



STD spec. : 2.9 t : 2430 x 1855 x 1875 mm
SE spec. : 3.7 t : 2280 x 1950 x 2100 mm

Boom & arm cylinder

STD spec. : Total 2.3 t
SE spec. : Total 2.5 t

4 Kits Transportation

Work equipment assembly

Weight : STD spec. : 17.1 t
SE spec. : 18.1 t

Boom

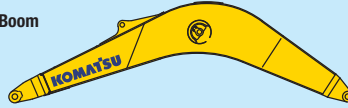

STD spec. : 7.9 t : 8530 x 2615 x 1500 mm
SE spec. : 7.3 t : 7430 x 2480 x 1500 mm

Arm

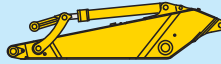

STD spec. : 4.0 t : 5115 x 1365 x 710 mm
SE spec. : 4.9 t : 4075 x 1690 x 715 mm

Bucket



STD spec. : 2.9 t : 2430 x 1855 x 1875 mm
SE spec. : 3.7 t : 2280 x 1950 x 2100 mm

Boom & arm cylinder

STD spec. : Total 2.3 t
SE spec. : Total 2.5 t

3 Kits Transportation

Work equipment assembly

Width : 2440 mm
Weight : 19.6 t

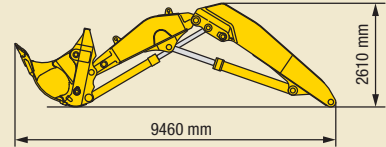

Base machine

Both PC800-8R1 and PC800-8R1 SE spec. are designed with the same weight and dimensions.

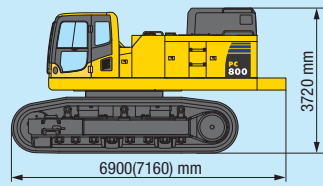

Width : 3390(3590) mm
Weight : 47.1(50.5) t

Upper structure

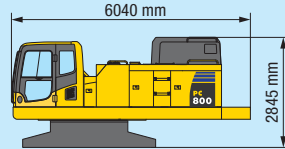

Width : 3225 mm
Weight : 26.3 t

Undercarriage

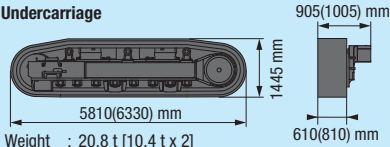

Weight : 20.8 t [10.4 t x 2]
(24.2 t [12.1 t x 2])

Base machine

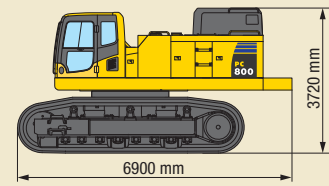

Width : 3390 mm
Weight : 47.4 t

Others

Weight : 10.3 t

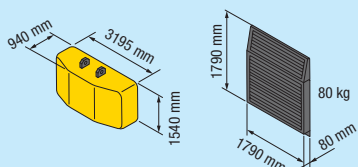

Weight : 9.8 t

Others

Weight : 10.3 t

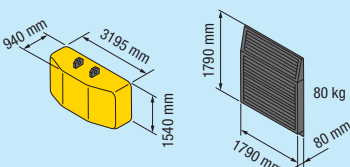

Weight : 9.8 t

Others

Weight : 10.3 t

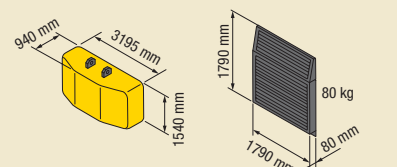

Weight : 9.8 t



STANDARD EQUIPMENT

ENGINE AND RELATED ITEMS:

- Air cleaner, double element, dry
- Engine, Komatsu SAA6D140E-5
- Variable speed cooling fan, with fan guard

ELECTRICAL SYSTEM:

- Alternator, 24 V/60 A
- Auto decelerator and auto idling system
- Batteries, 2 x 12 V/170 Ah
- Starting motors, 11 kW
- Step light with timer
- Working lights
2 boom, 1 right front, 2 on cab

UNDERCARRIAGE:

- 610 mm double grouser (PC800-8R1)
- 810 mm double grouser (PC800LC-8R1)
- 8 track/3 carrier rollers (Each side) (PC800-8R1)
- 9 track/3 carrier rollers (Each side) (PC800LC-8R1)
- Hydraulic track adjusters (Each side)
- Rock protectors
- Sealed track
- Variable track gauge

GUARDS AND COVERS:

- Dust-proof net for radiator and oil cooler
- Pump/engine room partition cover
- Travel motor guards

OPERATOR ENVIRONMENT:

- Cab with pull-up type front window
- Damper mount, all-weather, sound-suppressed cab with tinted safety glass windows, lockable door, intermittent window wiper and washer, floormat, cigarette lighter and ashtray
- Multi-function color monitor, electronically-controlled throttle dials, electric service meter, gauges (Coolant temperature, hydraulic oil temperature and fuel level), caution lights (Electric charge, engine oil pressure, and air cleaner clogging), indicator lights (Engine preheating and swing lock light) level check lights (Coolant, engine oil, and hydraulic oil level), self-diagnostic system with trouble data memory
- Rear view mirror (RH and LH)
- Seat, fully adjustable with suspension

HYDRAULIC CONTROLS:

- Control levers and pedals for steering and travel with PPC system
- Control levers, wrist control levers for arm, boom, bucket, and swing with PPC system
- Fully hydraulic, with Electronic Open-center Load Sensing System and engine speed sensing (Pump and engine mutual control system)
- Heavy lift mode system

- In-line filter
- Oil cooler
- One axial piston motor per track for travel with counter balance valve
- Power max function
- Shockless boom control
- Swing priority mode system
- Two axial piston motors for swing with single-stage relief valve
- Two control valves, 5+4 spools (Boom, arm, bucket, swing, and travel)
- Two-mode setting for boom
- Two variable capacity piston pumps

DRIVE AND BRAKE SYSTEM:

- Brakes, hydraulic lock travel brakes, oil disc parking
- Hydrostatic two travel speed system with planetary triple reduction final drive

OTHER STANDARD EQUIPMENT:

- Automatic swing holding brake
- Catwalk
- Counterweight, 9800 kg
- Horn, electric
- Large handrails
- Marks and plates, English
- One-touch engine oil drainage
- Paint, Komatsu standard
- Preventive Maintenance (PM) tune-up service connector
- Rear reflector
- Slip-resistant plates
- Travel alarm
- Water separator



OPTIONAL EQUIPMENT

- 12 V electric supply
- Additional track guard
- Alternator, 24 V/90 A
- Arms (Backhoe):
PC800/800LC-8R1:
—3600 mm arm assembly
—4600 mm arm assembly
—5600 mm arm assembly
PC800/800LC-8R1 SE spec.:
—2945 mm SE arm assembly
- Arm (Loading shovel):
—3400 mm arm assembly
- Attachment piping specification equips for breaker installation.
(For PC800/800LC-8R1 SE spec.)
- Automatic air conditioner (A/C)

- Booms (Backhoe):
PC800/800LC-8R1:
—8200 mm boom assembly
PC800/800LC-8R1 SE spec.:
—7100 mm SE boom assembly
- Boom (Loading shovel):
—4600 mm boom assembly
- Cab front guard level 2 (ISO 10262)
- Cab with fixed front window
- Coolant heater
- Counterweight, 11850 kg
- Double flange track roller
- Electric pump, grease gun with indicator
- Fire extinguisher
- Full length track roller guard
- General tool kit
- High cab mount
- Interconnected horn and warning light
- Large-capacity batteries

- Lower wiper
- OPG top guard level 2 (ISO 10262)
- Provision for fast fuel fill
- Radio AM/FM
- Rain visor
- Rear view monitor system
- Seat belt 78 mm, 50 mm
- Shoes (Backhoe):
—710 mm double grouser (PC800-8R1)
—810 mm double grouser (PC800-8R1)
—910 mm double grouser (PC800-8R1)
—1010 mm double grouser (PC800/800LC-8R1)
- Shoes (Loading shovel):
—710 mm double grouser
- Spare parts for first service
- Strengthened revolving frame underguard
- Sun visor
- Track frame undercover (Center)
- Vandalism protection locks

<https://home.komatsu/en/>

Printed in Japan 201801 IP.As

KOMATSU®